

Pro.2

Providing AV Solutions

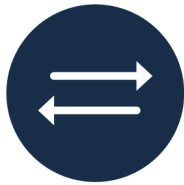

COMMUNICATION



DISTRIBUTION



CUSTOMISABLE



FAST

2018

FULL PRODUCT BROCHURE
CONNECTING AV HARDWARE



AV ACCESSORIES

- 4-5 AV CONVERTERS
- 6-8 AV SELECTORS
- 9-13 AV EXTENDERS
- 14 MODULATORS
- 15-23 MULTIROOM AV DISTRIBUTION
- 24-27 REMOTE CONTROLS
- 28 SPEAKER ATTENUATOR
- 28 SPEAKER DISTRIBUTION
- 29 SPEAKER SWITCH BOXES

CABLE & CABLE ACCESSORIES

- 31 STEREO LEADS
- 32-33 AUDIO LEADS
- 34-46 COMPUTER LEADS
- 47 TV FLYLEADS
- 48-53 VIDEO LEADS

COMPONENTS

- 55-58 PLUGS, SOCKETS & ADAPTERS
- 59-69 WALLPLATES

IT SUPPLIES

71-72

SECURITY & INTERCOMS

73

PUBLIC ADDRESS

73





AV ACCESSORIES

- 4-5 AV CONVERTERS
- 6-8 AV SELECTORS
- 9-13 AV EXTENDERS
- 14 MODULATORS
- 15-23 MULTIROOM AV DISTRIBUTION
- 24-27 REMOTE CONTROLS
- 28 SPEAKER ATTENUATOR
- 28 SPEAKER DISTRIBUTION
- 29 SPEAKER SWITCH BOXES

HDMI TO COMPOSITE CONVERTER



- Converts HDMI to Analogue Composite Video and Stereo Audio
- PAL / NTSC / Auto format switch
- Only converts Stereo PCM audio to analogue. Multi-channel and proprietary formats (eg. Dolby and DTS) are not supported

HC01 64550085 HDMI TO COMPOSITE CONVERTER

HDMI TO VGA CONVERTER



Convert HDMI input to RGB HV/ YPbPr/ YCbCr output with a 15 pin HD-sub (VGA style) jack.

- Two digital HDMI 19 pin ports
- Two channel input can be switched easily
- RGB 4:4:4 (8-bit) digital input

HVY02 64550185 HDMI TO VGA CONVERTER

HDMI TO DVI + AUDIO CONVERTER



Converts HDMI to DVI & extracts audio signals in both digital and analogue formats.

- Supports up to 1080p/60Hz
- Outputs stereo analogue audio (PCM to Analogue conversion only; no Dolby or DTS Decoding)

HD02ECO 64550100 HDMI TO DVI + AUDIO CONVERTER

HDMI UPSCALER



If your 4K TV manufacturer skimmed on the built-in scaling chipset, then your hi-res panel is going to waste! Take full advantage of your 4K panel and use the SC4K2K to do the up-scaling for you!

- 1080p to 4K HDMI scaler
- 4x user selectable operating modes
- 3D 1080p pass-through modes
- Audio extraction via TOSLINK/optical socket
- Full CEC pass-through



SC4K2K 64550115 1080P FULL HD TO 4K SCALER

VGA AUDIO TO HDMI CONVERTER



- 3.5mm stereo upscales VGA signals to 720p/1080p (user-selectable)
- Converts computer VGA video signal and audio to HDMI output
- Hardware conversion, plug and play without software or drivers
- HDCP 1.1 protocol compliant

VH03 30251945 HIGH DEFINITION VGA TO HDMI CONVERTER

VGA TO HDMI MINI CONVERTER



The Mini VGA to HDMI converter can convert analog PC (RGBHV) and audio signal to digital HDMI format. It can connect the analog HD-15 VGA output from PC to the digital HDMI input of the latest HD ready LCD, LED, OLED or DLP TV. Its high bandwidth capability supports a wide range of PC and HDTV resolutions.

VH04 30251975 MINI HIGH DEFINITION VGA TO HDMI CONVERTER

COMPOSITE TO HDMI CONVERTER



The MINI AV2 HDMI converter is a universal converter for analogue composite input to HDMI 1080p output. The analogue to digital conversion in this module employs 10 bit sampling, black/white level expansion, colour transition improvement, dynamic range expansion, blue stretch, auto-detect and auto-convert. It can deliver the sharpest, most realistic HD visuals.

AV2HDMI 64550106 MINI PASSIVE 1080P UPSCALER

DIGITAL-ANALOGUE CONVERTERS



	PR01259	64550001	TOSLINK S/PDIF	→	ANALOGUE STEREO	DIGITAL TO ANALOGUE CONVERTER WITH DIGITAL LOOP-OUT
	PR01262	64550010	TOSLINK S/PDIF	←	ANALOGUE STEREO	ANALOGUE TO DIGITAL CONVERTER WITH SELECTABLE SAMPLE RATE
	PR01287	64550015	TOSLINK	↔	S/PDIF	DIGITAL CONVERTER
	PR01298	64550020	TOSLINK S/PDIF ANALOGUE	↔	TOSLINK S/PDIF ANALOGUE	UNIVERSAL DA / AD / DD CONVERTER WITH INPUT SELECT

DIGITAL TO ANALOG DECODER



High quality DAC converts S/PDIF & TOSLINK (PCM, DTS, & Dolby formats) to Analogue output.



			INPUT	OUTPUT	
	DAC212	64550090	TOSLINK S/PDIF	2ch	DIGITAL TO ANALOGUE DECODER
	DAD51	64550095	1X TOSLINK 2X S/PDIF STEREO ANALOGUE	5.1ch	DIGITAL AUDIO DECODER

PAL/NTSC CONVERTER



Convert all composite formats to PAL or NTSC (selectable via switch).

- Includes audio-through for neat installation

PNC616 64550110 PAL/NTSC CONVERTER

HDCP2.2 TO HDCP1.4 CONVERTER



HDCP 2.2 is the new copy-protection standard for many modern source devices like UHD players and streaming services, such as Netflix. This box is perfect for playing your HDCP2.2 content through your HDCP1.4 equipment!

- Compliant HDMI 1.4B
- Converts HDCP 2.2 to HDCP1.4
- Supports 4Kx2K @ 60Hz / YUV 4:2:0, audio format Dolby / DTS / LPCM
- Supports 3D / CEC

HDCP2214V2 64550157 **HDCP2.2** → **HDCP1.4** HDCP2.2 TO HDCP1.4 CONVERTER

AV SELECTORS

ANALOGUE AV SELECTORS



Switch between composite video and stereo audio sources.

- Easy push-button operation



AV212	64530995	2-WAY COMPOSITE AV SELECTOR
AV313	64531002	3-WAY COMPOSITE AV SELECTOR
PR01048	64531006	4-WAY COMPOSITE AV SELECTOR

COMPONENT SELECTORS



Increase your system's component and coaxial audio inputs!

- Instant one-touch switch and simple do-it-yourself installation
- Stylish housing

HD4DCAD	64531010	COMPONENT + STEREO + COAX	4-WAY COMPONENT VIDEO SELECTOR
----------------	----------	----------------------------------	--------------------------------

HDMI SELECTORS

DIGITAL AV SELECTORS

GOLD
PLATED CONNECTORS

Deep Colour
x.v.Colour



HDMI5SM

Connects up to three or five HDMI sources to one HDMI display device.

- Maintains 480p, 720p, 1080i and 1080p video formats
- Supports 3D & HDCP
- Maintains highest HDMI single link video resolution and digital audio signal
- No power supply required for short HDMI runs!



HDMI3SM

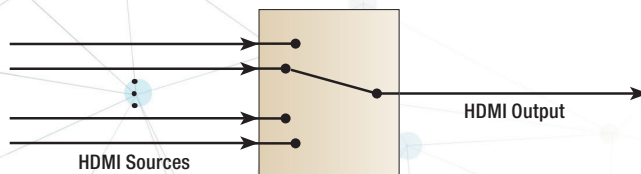

HDMI3SM	64538007	3-Way	3-IN 1-OUT MINI HDMI SWITCHER
HDMI5SM	64538009	5-Way	5-IN 1-OUT MINI HDMI SWITCHER

DIGITAL AV SELECTORS

HDMI SELECTOR WITH ARC



GOLD
PLATED CONNECTORS



Deep Colour
x.v.Colour



Add extra HDMI Inputs to your TV without having to upgrade your entire system!

- Audio Channel return function outputs audio from your TV so you don't have to change inputs on your Receiver/Amplifier
- 3D formats supported
- Supports digital coaxial + optical audio output for sound system lacking HDMI connections
- Supports 1080p Deep Colour

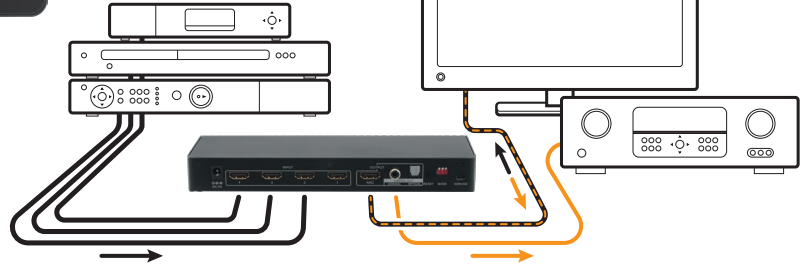

HDMI4AVR 64538014 4-WAY HDMI SWITCH WITH ARC+3D

TOSLINK SWITCHER

3-in 1-out Powered TOSLINK Switch with Remote Control. Attach up to three Optical Toslink audio sources to a single receiver and select one input source to be sent to one of three connected devices.

- Audio formats supported: LPCM2.0 / DTS / Dolby-AC3
- Output distance is up to 40m
- The input selection can be made via remote or button on unit
- Supports signal re-timing



PRO1376 64538019 TOSLINK DIGITAL AUDIO SWITCH

HDMI 4X1 QUAD MULTI VIEWER

- HDMI 1.4b, HDCP 1.4 and DVI compliant
- Video resolutions up to 1080p@60Hz
- Audio supports LPCM 2/5.1/7.1CH, Dolby 5.1CH, Dolby True HD, DTS-HD
- Quad multi-viewer with five display modes supported
- Audio output can be selected come from any one of the input sources
- Button, IR remote, RS232 control

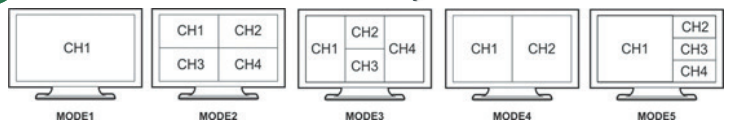

HD41QMV 07350810 4 IN 1 OUT SWITCH RS232 5 MODES

3 IN 1 OUT HDMI SWITCHER WITH AUDIO EXTRACTION

The latest PRO2 3 in 1 out HDMI switch. Now supports ultra HD 4K, ARC and CEC. Connects up to 3 devices including your mobile phone, Apple TV, Xbox and more devices all at once with audio extraction.

- Input can be selected by either remote or the button on the unit
- HDMI input 1 supports MHL devices (eg. Samsung galaxy S3/S4/S5) by using MHL-HDMI cable
- Supports Audio Return Channel
- Three audio EDID settings: 2.0CH/5.1CH/AUTO;
- SPDIF output supports up to 5.1CH Dolby Digital, DTS Audio



HDMI3S4K 64510370 3 IN 1 OUT HDMI SWITCH

18GBPS 4X1 HDMI 2.0 SWITCH

- Support 4K@60Hz YUV4:4:4
- HDCP2.2, CEC, ARC
- Supports HDR10
- Supports 4xHDMI in, IR or switch button to choose source out
- Supports output with audio extraction, RCA 2.0 SPDIF 5.1
- Supports audio mixing, Aux 2.0, SPDIF 5.1
- Supports Dolby True HD and DTS-HD master audio



HDMI4S18G 64510380 4 IN 1 OUT HDMI SWITCH

4-IN 4-OUT HDMI MATRIX

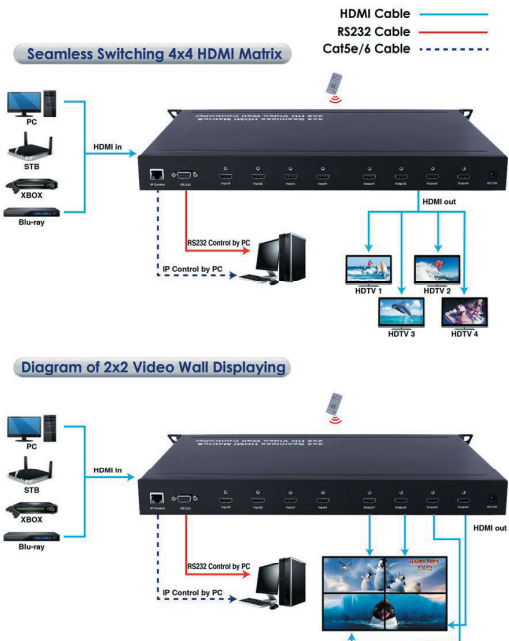

True matrix set-ups allow any source – Blu-ray player, satellite receiver, HD game consoles etc. – to be shown on any display connected. For example, you can switch to your Pay TV box on your kitchen TV while the kids are simultaneously playing a Blu-ray movie on the bedroom TV. You can also view the same source on more than one display!

		IN	OUT	RS232	
HDMIMX4422	64510360	4	4	•	2X2 VIDEO WALL

18GBPS 4-IN 2-OUT HDMI MATRIX

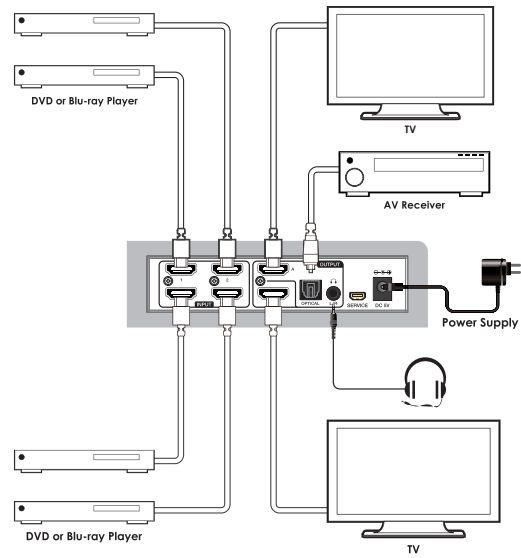

The 4x2 HDMI 2.0 Matrix Switcher simultaneously routes four HDMI sources to two HDMI displays. It supports up to 4K2K@60Hz YCbCr 4:4:4 and HDCP 2.2. Output A supports audio de-embedding to optical and analog L/R outputs. Output B can support 4K to 1080p downscale function automatically if source is 4K but TV only supports up to 1080p. 16 different EDID configurations can meet most of use cases. Flexible control through on-panel buttons, IR control.

		IN	OUT	EDID	
HDMIMX42V2	64510199	4	2	•	18GBPS

18GBPS HDMI 8X8 MATRIX

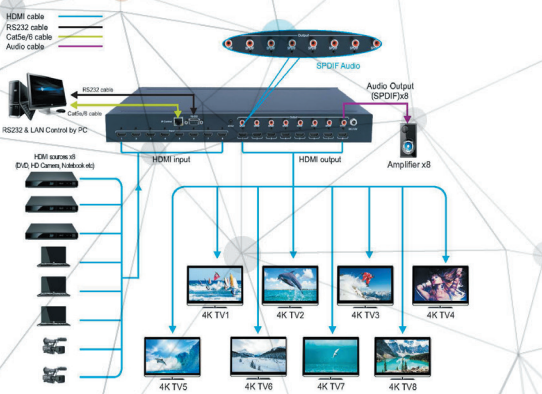

HDMIMX88V2 is a HDMI 8x8 matrix that supports HDMI2.0. It can take up to 8 HDMI inputs and distributing them to 8 individual HDMI outputs.

- Supports HDMI 2.0
- Bandwidth up to 18Gbps

		IN	OUT	SPDIF	
HDMIMX88V2	64510337	8	8	8	18GBPS

EXTENDER

COMPOSITE VIDEO & STEREO AUDIO OVER CAT5 EXTENDER



The PRO1221 sends composite video and stereo audio signals over long distances using economical CAT5 cable allowing you to distribute video and sound easily and efficiently.

- Includes 2 modules to transfer AV signals
- Distance: Up to 300m

PRO1221 07350080 TRANSMITTER & RECEIVER

COMPOSITE VIDEO & STEREO AUDIO PLUS IR OVER CAT5 EXTENDER



Send composite video and analogue stereo audio over a single CAT5 cable up to 300m with the PRO1211. The PRO1211 also supports IR return with the connection of the included IR target and emitters.

PRO1211 07350120 TRANSMITTER & RECEIVER

COMPONENT VIDEO STEREO AUDIO OVER CAT5 EXTENDER



Extend the reach of your component video and stereo audio signals using economic CAT5e cable.

PRO1276 07350095 TRANSMITTER & RECEIVER

STEREO AUDIO OVER CAT5 EXTENDER



- Set of 2 audio baluns one transmitter and one receiver
- For analog stereo audio only
- Bi-directional so each end can perform either transmitting or receiving
- Adaptor length: 10cm
- Suits CAT5/5e/6

PRO1363A 07350051 RCA MALE TO RCA MALE

PRO1363 07350053 3.5MM STEREO + 3.5MM STEREO

DIGITAL AUDIO OVER CAT5/6 EXTENDER



Listen and control digital audio sources up to 200m over a single CAT5e/6 cable.

- Transmit digital signals with a single CAT5e or CAT6 cable
- Up to 200 metres distance
- IR return
- Selectable input - TOSLINK or S/PDIF
- Supports multichannel audio

PRO1362D 07350047 DIGITAL AUDIO CAT5/6 EXTENDER

HDMI USB2.0 KVM EXTENDER

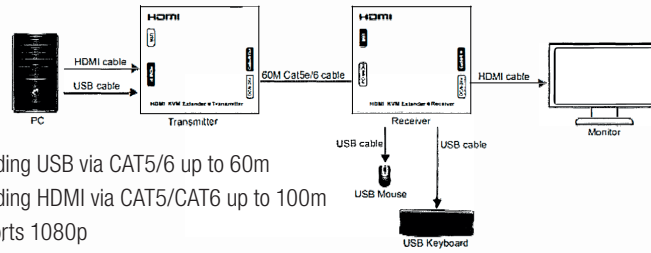

HDMI

- Extending USB via CAT5/6 up to 60m
- Extending HDMI via CAT5/CAT6 up to 100m
- Supports 1080p

HDMIKVMV2 07351029

TRANSMITTER & RECEIVER

HDMI OVER SINGLE CAT6 EXTENDER WITHOUT IR



Transmit HDMI Signal over 50m single CAT5e/6 without signal loss.

- EDID reading and saving from display
- Easy to install, no extra settings
- Support high definition resolution up to Full HD 1080p
- Support Dolby True-HD, DTS-HD Master audio
- EDID reading and saving from display
- Bandwidth can be up to 6.75Gbps
- 2x DC 5V 1A power supply (included)
- 4K/2K incompatible



Deep Colour
x.v.Colour

HDC6ECO 07351034

TRANSMITTER & RECEIVER

HDMI OVER SINGLE CAT6 EXTENDER WITH LOOP OUT/IR



- Transmit HDMI signal over 50m via single CAT5e/6.
Supports PCM, Dolby Digital, and DTS Digital Surround.
- Support high definition resolution up to Full HD 1080p
 - Supports 3D formats

HDC6L 07351046 TX/RX Pair LOOPING HDMI OUT/EDID/3D - WITH IR

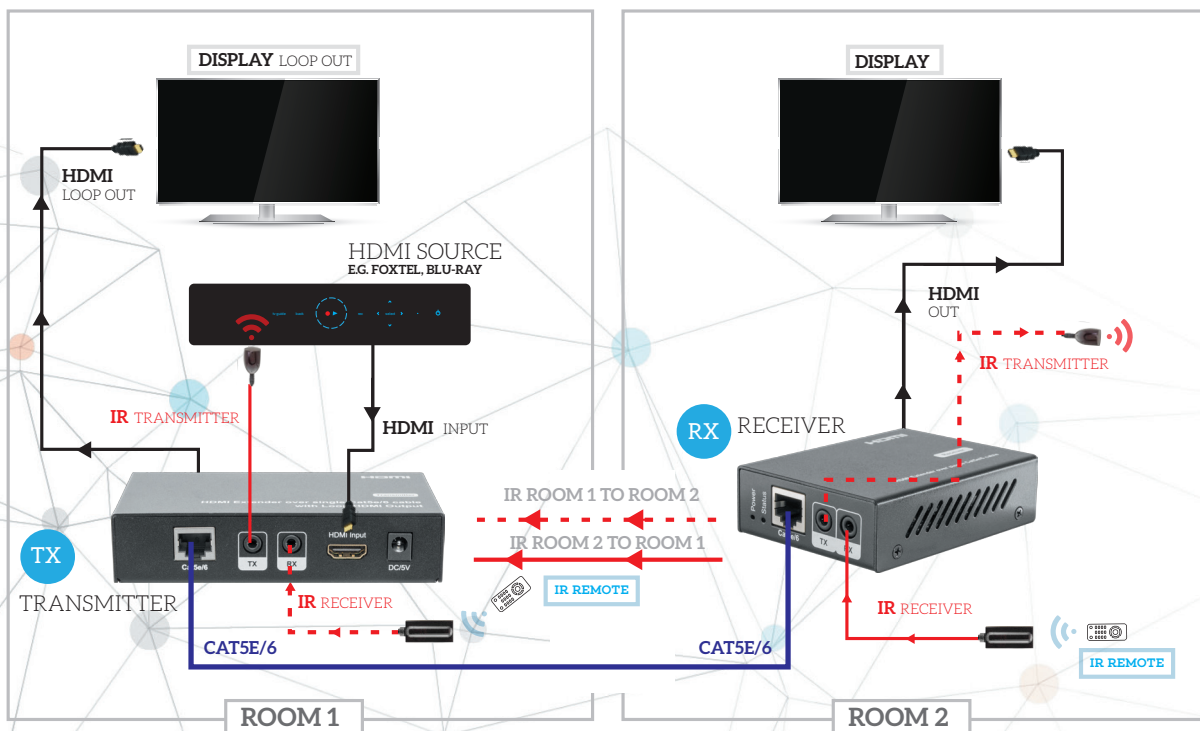

HDMI OVER IP DISTRIBUTION

MJPEG COMPRESSION

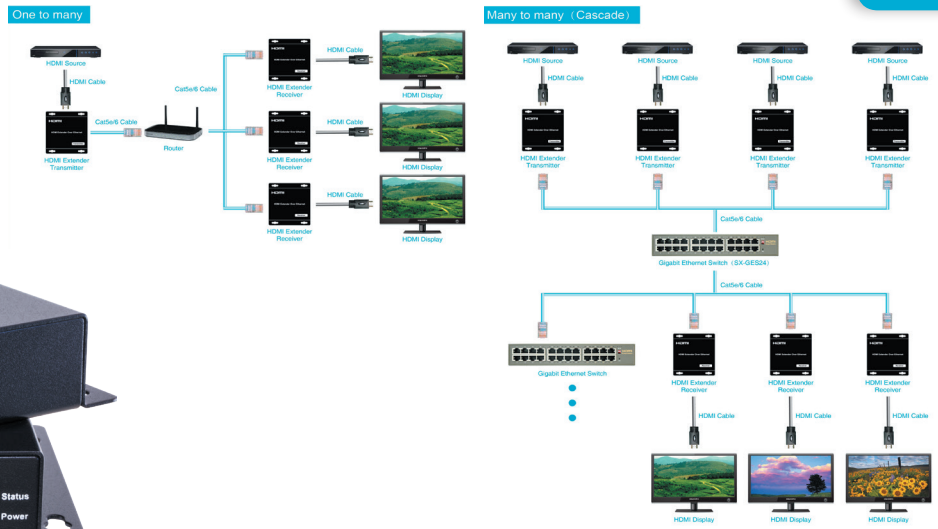

- HDMI over IP extender.
- Extending HDMI signal up to 120m
- Supports one-to-one, one-to-many
- HDCP compliant

	HDMI IPECOV2	07351120	TRANSMITTER & RECEIVER
	HDMI IPECOV2RX	07351122	SPARE RECEIVER

HDMI OVER IP EXTENDER WITH POE

H.264 COMPRESSION

SUPPORTS
ONE TO ONE,
ONE TO MANY
MANY TO MANY



HDMIIPRO CONTENTS:

- 1x Transmitter
- 1x Receiver
- 1x IR-TX cable
- 1x IR-RX cable
- 4x Detachable Mounting Ears
- 2x Phoenix Plugs For RS232 Cable Termination
- 2x Remote Control
- Supports one to one, one to many, many to one, many to many modes
- Can be powered by either power supply or POE
- Supports resolution up to 1080p@60Hz
- With IR remote for source selection. LED front panel showing group ID
- Complies with TCP/IP protocol, Streaming bit rate is up to 15Mbps
- Supports DHCP for easy IP address assigning and LPCM audio format
- HDCP compliant
- Supports PC tool control



This HDMIIPRO HDMI over IP Extender uses advanced H.264 compression which transfers signal using lower bandwidth thus smoother transmission. It supports 120m over single CAT5e/6 cable at point to point. A great HDMI over IP solution for meeting rooms, class rooms and homes etc.

DISTRIBUTE YOUR AV SIGNALS THROUGH YOUR NETWORK!

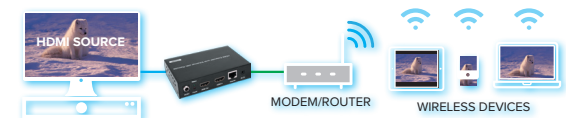

ONE TO MANY! MANY TO MANY!

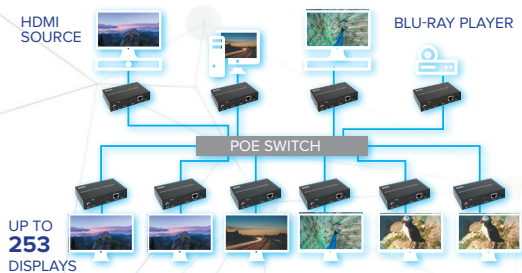

	HDMIIPRO	07351065	TX/RX Pair	HDMI OVER IP EXTENDER WITH POE
	HDMIIPRORX	07351066	Receiver only (RX)	SPARE RECEIVER FOR HDMIIPRO

HDMI EXTENDER OVER ANY WIRE



HDMI AW can extend your HDMI source over any 2-conductor cable including twisted cable, telephone cable or CAT5/6 etc. The transmitter compresses/converts the HDMI signals into a serial data stream, which is then encoded for transmission over any copper media. It is an ideal HDMI extender over your existing cable.

- With 1x Loop HDMI output at transmitter
- Transmit HDMI signal up to 3.8km
- Supports multi-level cascading
- HDMI resolution up to 1080p
- HDCP compliant
- IR pass-through control
- Power supply DC 12V

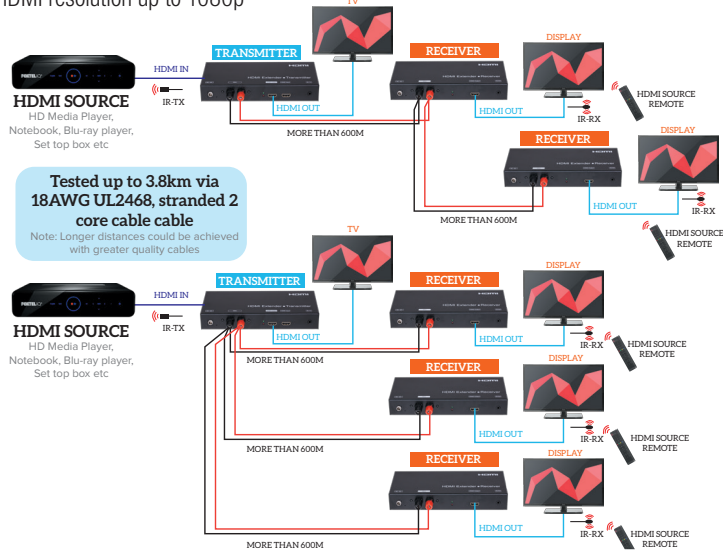

Tested up to 3.8km via 18AWG UL2468, stranded 2 core cable cable
 Note: Longer distances could be achieved with greater quality cables

	HDMI AW	64510347	HDMI EXTENDER OVER ANY WIRE
	HDMI AW RX	64510348	SPARE RECEIVER

HDMI OVER LC FIBRE EXTENDER



HDMI over fibre extender base only.

- Transmit from 1m to 60km depending on module
- Supports resolution up to 4K x 2K @60Hz, YUV4:2:0
- Supports bandwidth up to 10.2Gbps

Related Products:

FIBRE CABLES
 See page 37



	HDMI FIB 4K	64510352	HDMI OVER FIBRE EXTENDER
--	--------------------	----------	--------------------------

18GBPPS HDMI OVER FIBRE EXTENDER



- Transmit distance from 1Km to 60Km over Single /Multi mode, Single /Duplex fiber (depending on the fibre module)
- Support resolution upto 4K x 2K@60hz, YUV4:4:4 HDR
- Without latency
- Support HDCP2.2 input, HDCP2.2 output, HDCP1.4 input, HDCP1.4
- Support RS232 Bi-direction pass through
- With Automatic EDID for rapid integration of source and display
- Support LPCM 7.1, Dolby True HD, DTS-HD Master Audio
- Locking power supplies
- Surface-mountable



	HDMI FIB 18G	64510358	18GBPPS HDMI OVER FIBRE EXTENDER
--	---------------------	----------	----------------------------------

HDMI OVER COAXIAL EXTENDER



The HDMI extender over 1 coaxial cable with IR control is the right way to send your HDMI signal over long distances. Instead of using expensive HDMI cables, this device lets you use your existing coaxial cables/sockets while also performing the same functions like transferring Deep Colour (12 bits/colour) video, all with a bandwidth up to 225MHz. And if that wasn't enough, you can use your existing remote to control your device through an IR blaster.

Deep Colour
 x.v.Colour



HDVC100 07350800 SINGLE COAXIAL 100M WITH IR CONTROL

HDMI 2.0 4K 2K REPEATER



- Bandwidth up to 18 Gbps
- Resolution up to 4K x 2K@60Hz, YUV4:4:4
- HDCP 2.2/1.4 compliant

HR04 30254289 HDMI2.0 4K2K REPEATER

4K HDMI AUDIO EXTRACTOR

SPDIF STEREO



Deep Colour
 x.v.Colour

Extract the digital HDMI audio signal from the HDMI input to 2 channel analog stereo output or 5.1 channel Audio output.

- Supports resolution up to 4K@60hz, YUV4:2:0 (HA01) or 4K@60hz, YUV4:4:4 (HA02)
- Three Audio EDID Settings: 2.0CH/5.1CH/By pass
- The HA01 supports Apple TV and most Blu-ray players & the HA02 supports everything!



HDMI Cable
Audio Cable
SPDIF Cable

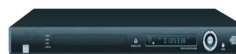

DVD-Player

HDMI Input



HDMI Output

SPDIF Output

Analog Audio Output



4K TV



Amplifier



Multimedia Speaker



Deep Colour
 x.v.Colour



HA01 64550087 10.2GBPS
HA02 64510385 18GBPS

ANALOGUE DEMODULATOR

ANALOGUE MODULATORS



Watch TV or Composite input on your Computer monitor. With built-in multimedia tuner, it presents crystal clear and flicker free pictures.

- 1920x1200, 1920x1080 Support
- PIP (Picture in Picture)

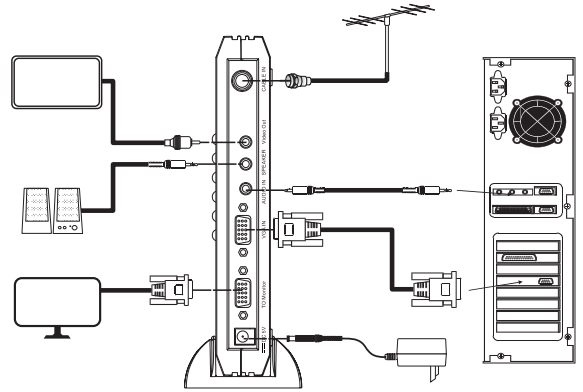

- Video Entertainment on your PC
- Easy to use remote control

ADM5 37400014 ANALOGUE DEMODULATOR COMPOSITE

RF MODULATOR

The ultimate universal AV modulator. Connect any AV device via Composite AV, or RF and output to any television with an RF input. An ideal solution for "Cascade Surveillance" systems.

- Adjustable Channels
- Antenna In/Out
- RCA (CBVS) Inputs
- 2x Seven Segment LEDs Display
- Power supply included



RFMX3

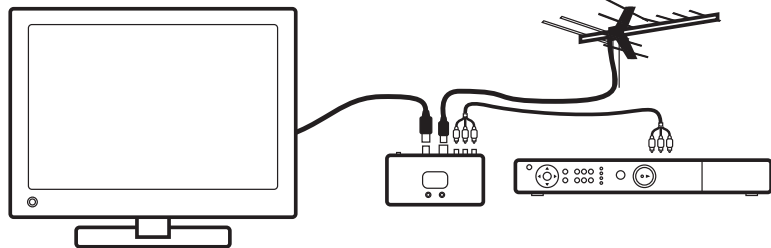

RFMX3IR

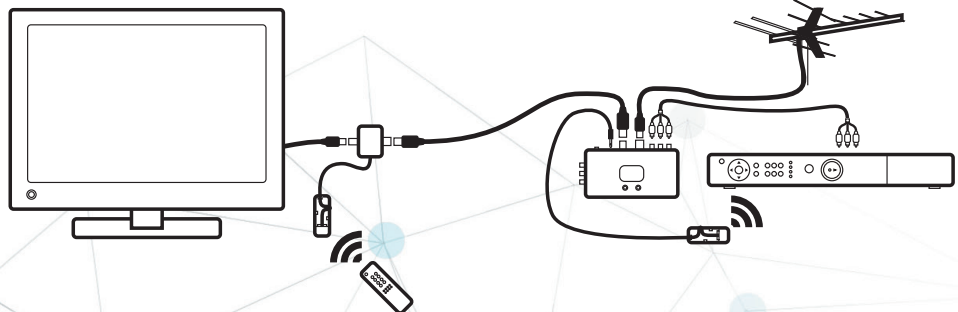

	RFMX3	37400050	with gain control	3-INPUT RF MODULATOR
	RFMX3IR	37400052	with IR over RF	3-INPUT RF MODULATOR
	RFMX3IRST	37400054		SPARE IR TARGET FOR RFMX3IR

4-WAY VGA SPLITTER



- Video Bandwidth: >500MHz
- Supported Resolutions: VGA, SVGA, XGA, SXGA, UXGA, QXGA, WUXGA, WQXGA
- Gain and EQ Adjustments
- Input/Output Connector: HD-15 Female

PRO1296 00760650 4-WAY VGA + PC AUDIO SPLITTER

ACTIVE TOSLINK SPLITTER



2-In 4-Out Toslink Audio Switcher/Splitter.

- Supports digital audio signal (Coaxial/Optical) input and 4 optical outputs
- Built-in audio amplifier ensures loss-less signal integrity
- Supports 2CH LPCM audio signal (sampling rate up to 192kHz)
- Supports Dolby and DTS audio signal
- Supports sampling rate from 32kHz to 192kHz
- Suitable for home or professional audio distribution

PRO1359 30251890 ACTIVE TOSLINK SPLITTER

2:4 VGA MATRIX



Perfect for bars, club houses, and function spaces; distribute two PC sources to up to four different zones independently!

- Two PC inputs with 'PC On' indicator
- Four outputs/zones each feature source selector switch with indication LED
- Boosts signals for transmission up to 65m for VGA and 100m for Audio
- 2x VGA inputs / 4x VGA outputs
- 2x Audio Inputs / 4x Audio outputs (3.5mm Stereo Jack)



PRO1338 00760652 2-IN 4-OUT VGA + AUDIO MATRIX

4-WAY AV DISTRIBUTION AMP



This audio video distribution amplifier lets you split video and stereo audio output signals from a DVD, or other video sources without any signal loss.

- Send video and stereo audio signals to as many as four other TVs
- Maintain picture quality when driving up to four TV monitors

PRO1047 00760656 4-WAY AV DISTRIBUTION AMP

UP TO 4-ZONE AV COMPOSITE EXTENDER

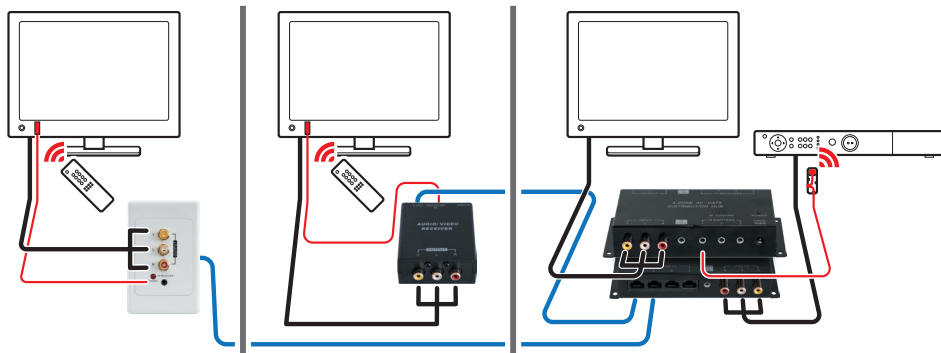

Distribute composite video and stereo audio plus IR signals using economical CAT5 cable.

- Designed to be surface mounted for in-wall composite video, and stereo audio with IR return
- The system can be expanded up to 4 zones with additional PRO1235DS spare receivers

	PRO1235D	39894086	Kit (TX + RX)	AV DISTRIBUTION OVER CAT5
	PRO1235DS	39894087	Spare receiver	SPARE RECEIVER FOR PRO1235D
	PRO1235DSWP	39894085	Wallplate receiver	WALL PLATE RECEIVER FOR PRO1235D

UP TO 4-ZONE HDTV EXTENDER

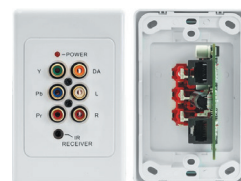

The PRO1247D allows you to extend component video, coaxial digital audio, stereo audio and IR signals to 4 different zones (expandable up to 8 with loop out function) using economical CAT5e cable.

Your source AV device (eg. DVD player) connects to the distribution hub and a 2 CAT5e cable connection is made to the receiver which is connected to your display device (eg.TV).

- Four zone Audio/Video + IR distribution
- Send HD video and audio signals up to 120 metres
- Transmit IR signals to remotely control AV devices
- Supports 480p to 1080p



	PRO1247D	39894088	Kit (TX + RX)	4-ZONE HDTV + IR OVER CAT5
	PRO1247DS	39894089	Spare receiver	SPARE RECEIVER FOR PRO1247D
	PRO1247DSWP	39894090	Wallplate receiver	WALL PLATE RECEIVER FOR PRO1247D

UP TO 4-ZONE VGA OVER CAT5 EXTENDER

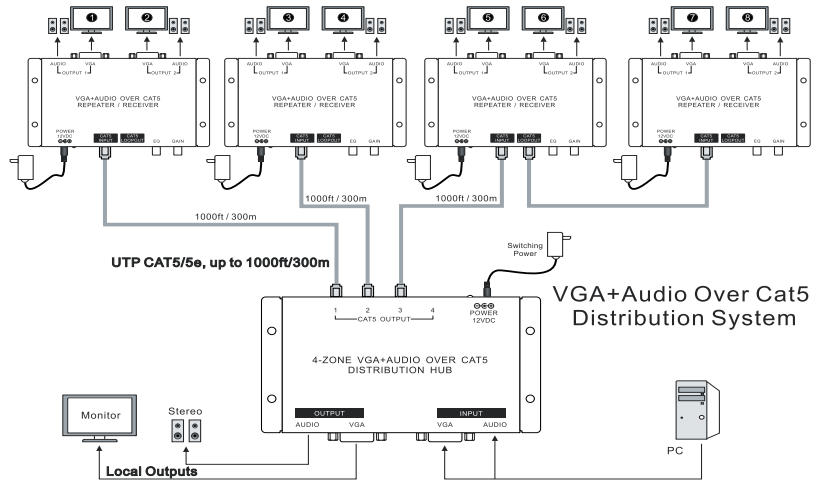

- Distribute a VGA+Audio signal via single UTP CAT5/5e to up to 4 zones (8 outputs)
- Transmission Distance up to 300m (1000ft) via UTP CAT5/5e
- With the loop-out function on the receiver, it can support up to 5 zones
- Provides 4x RJ45 outputs for transmission



	PRO1270	39894094	TX + RX Kit	VGA & AUDIO OVER CAT5 BALUN PAIR
	PRO1270S	39894096	RX only	SPARE/EXTRA RECEIVER FOR PRO1270

HDMI ENCODER FOR IP TV



HE01 H.264 HD HDMI encoder is the ideal tool to convert your HDMI resource into IP sharing resource. Great for multimedia display walls, video conferencing, IP TV projects etc.

- H.264 encoding
- UDP, HTTP, RTSP, RTMP, Onvif protocol
- MPEG1 audio layer 2
- CBR/VBR rate: 16kbps-16Mbps
- 1000M network interface uses full duplex mode
- Supports up to 720p, 1080p@60Hz HD video input
- Image parameter settings
- WEB interface management authority
- Remote management in WAN (WEB)
- One key to restore factory configuration

HE01	43151280	H.264 HDMI ENCODER FOR IP TV
-------------	----------	------------------------------

1080P FULL HD VIDEO CAPTURE



The Pro.2 HDVC01 records your HDMI video input—up to 1080P—directly to USB storage in h.264 encoding: no computer required!

- Supports HDMI signal source of PlayStation 4, Xbox One and Xbox 360 game play in brilliant 1080p@60Hz with advanced H.264 encoding
- Recording with one-click, easy to use. It doesn't require any set up just click "RECORD" button to record your game play and re-click to stop recording. Automatically splits the video files up to 2GB per file
- Supports MPEG-4 and RCA L/R 3.5mm microphone audio inputs
- Upscales or downscales to 720p

HDVC01	09002112	VIDEO RECORDING WITH HDMI INPUT
---------------	----------	---------------------------------

4K HDMI SPLITTERS

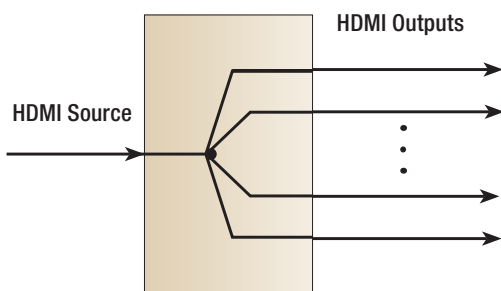

Particularly all AV content is below 10.2Gbps, meaning that most consumers will choose the more economical 4K splitters here.

Consumers wanting the ultimate or to be future proofed, should select the 18Gbps splitters below.

	HDMI2SP	64510010	2-Way	EDID
	HDMI4SP	64510020	4-Way	EDID
	HDMI8SPEDID	64510032	8-Way	EDID
	HDMI16SPEDID	64510042	16-Way	EDID

4K 18 GBPS HDMI SPLITTERS

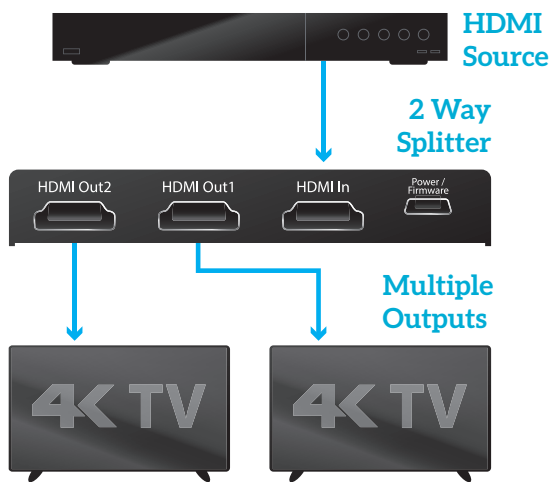

One input signal can be split to up to 16 HDMI devices. Our range provides an ideal solution from a simple home installation to a massive 16 monitor commercial installation. All models come in a robust metal case that is made up of a solid construction that is built to last. The Pro2 HDMI splitters are also powered, meaning they also help you extend your cable runs by equalising your signals and reclocking them before passing them onto the displays.

- Slim design, great for hiding behind TVs
- Up to 4K HDMI 2.0 UHD
- Display resolutions up to 3840 x 2160
- Built-in EDID simulator and HDCP key-set



	HDMI2SPV2	64510014	2-Way	EDID
	HDMI4SPV2	64510024	4-Way	EDID
	HDMI8SPV2	64510034	8-Way	EDID

SPC5L SERIES - HDMI OVER UTP SPLITTER WITH IR



These HDMI splitters over single CAT5e/6 enable you to split your source up to 50 metres with IR pass-through. Simply connect the SPC5RX (below) receiver to your destination and you are good to go!

- Provides a local HDMI loop-out for viewing locally or cascading (up to 4 layers! – see diagram over page)
- Supports full HD 1080p, VESA resolution 1920x1200, Dolby TrueHD, DTS-HD Master Audio, and 3D
- Wide-band bi-directional IR (36-56kHz) control
- 3D Full HD 1080p, VESA resolution 1920x1200
- Dolby TrueHD, DTS-HD Master Audio
- EDID DIP-switch



4-WAY H4SPC5L | 64510144



8-WAY H8SPC5L | 64510146

HDMI OVER CAT5 SPLITTER RECEIVER

Up to 50M + bi-directional IR

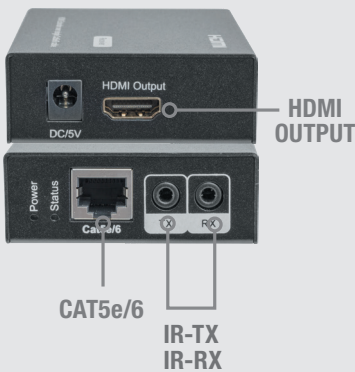

SPC5RX | 64510140

The SPC5RX is the bridge between any Pro2 SPC5L series HDMI over UTP transmitter and your HD display using a single CAT5e/CAT6 cable. Using the included IR transmitter and receiver, you are able to control your source device too!

	H2SPC5L	64510142	Transmitter only (TX)	2-WAY HDMI OVER CAT5 SPLITTER
	H4SPC5L	64510144	Transmitter only (TX)	4-WAY HDMI OVER CAT5 SPLITTER
	H8SPC5L	64510146	Transmitter only (TX)	8-WAY HDMI OVER CAT5 SPLITTER
	SPC5RX	64510140	Receiver only (RX)	HDMI CAT5 SPLITTER RECEIVER

Examples of Use

2-way Application

Use a H2SPC5L to play content to 3 devices 2x via SPC5RX and 1x via HDMI Loop-out. Use the other models to connect even more devices.

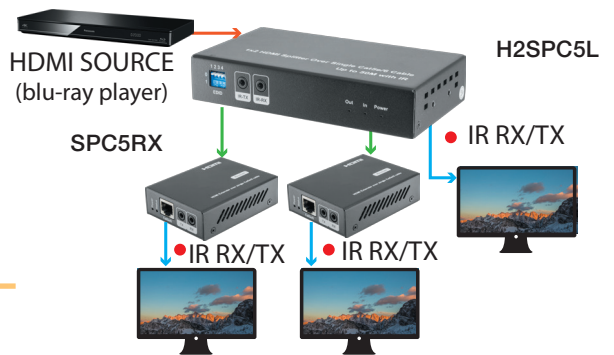

Cascading up to 4 layers

Use a multiple H2SPC5L transmitters to play content to multiple devices via SPC5RX receivers. Connect them together via the HDMI loop-out up to 4 levels. Need more displays? Then consider the 4 or 8 way splitters!

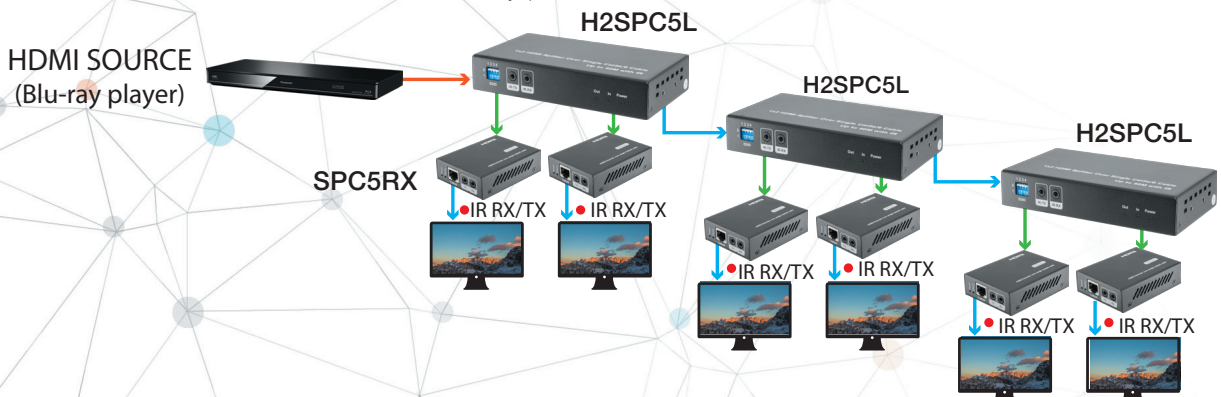

HEADPHONE AMP



Perfect for headphone displays in stores or create your own Silent Cinema room at home! Connect up to four sets of headphones, each with individual volume controls.



PRO1340	01458306	4-Way	4-WAY HEADPHONE AMPLIFIER
PRO1343	01458308	1-Way	HEADPHONE AMPLIFIER

PHONO PREAMP



In order to connect your turntable to the line-level inputs most amplifiers have (Aux, Tape, Line, Video, CD, etc.), you need to first pass the signal through an external preamp.

- Ultra compact design
- Use either 9V Battery or 9V / 100mA Power supply (not included)
- Simply plug and play
- Current consumption: 1mA (average)
- Amplification: 34dB

PA005	60850410	INLINE PHONO PREAMP
--------------	----------	---------------------

STEREO LINE PREAMP



This audio pre-amp is great for audio distribution systems where sources may have different output levels. Adjust the pre-amp gain so your source is matched with the others before entering your distribution or zone amps!

- Frequency Response: 20Hz to 20kHz
- Gain Control: 0-15dB
- S/N Ratio: >85dB

PRO1327	60850430	STEREO AUDIO LINE PREAMP
----------------	----------	--------------------------

RIAA PHONO PREAMP WITH AUX



Phono & Aux input selector.

- Phono Amplitude Gain: 40dB (@1kHz)
- AUX Amplitude Gain: 6dB
- Signal to Noise ratio: 70dB
- Precise RIAA (Recording Industry Association of America) equalization

PRO1387	60850435	RIAA PHONO PREAMP WITH AUX
----------------	----------	----------------------------

3-INPUT AMP

MULTIROOM AUDIO

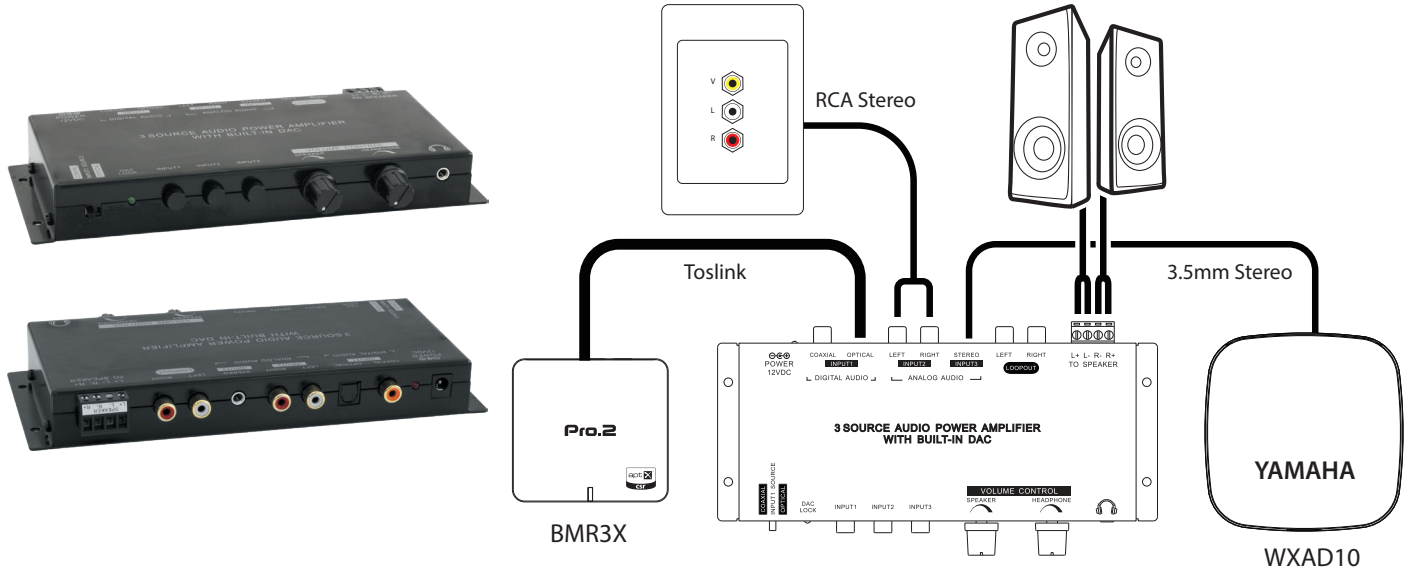

3-source Audio Power Amplifier with built-in DAC.

- Output power: 15W RMS per channel
- Amplifier Type: Stereo D-Class
- Digital Input Type: Coaxial & Optical
- Frequency Response: 32 – 192kHz sample rate

PRO1299 01458292 3-SOURCE AMP WITH BUILT-IN DAC

4-ZONE SPEAKER AMP



FRONT

REAR

- 4-zone speaker amplifier
- Analogue stereo input
- 15W per channel @ 4Ω
- Stereo loop-out for connecting multiple units
- Individual volume controls for each zone
- Headphone output for monitoring (with volume control)

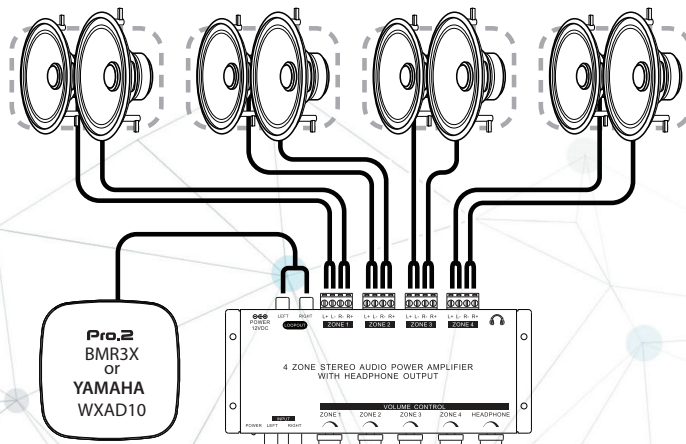

PRO1300 01458295 4-ZONE STEREO POWER AMPLIFIER

4-ZONE AMP WITH DAC



FRONT



REAR



The PR01323 is a quick and easy way of adding audio in up to four rooms.

- 4-zone speaker amplifier
- 15W per channel @ 4Ω
- Digital (Optical / Coaxial selectable), RCA Stereo, 3.5mm Stereo & Dynamic Microphone inputs
- Stereo loop-out for connecting multiple units
- Individual volume controls for each zone
- Headphone output for monitoring (with volume control)

PR01323 01458298

4-ZONE AUDIO POWER AMPLIFIER WITH DAC

STEREO AUDIO POWER AMPLIFIER



Use the PR01328 to power in-ceiling speakers with the audio output from any source device such as computers, DVD players, TVs and even Microphones.

- Small size and compact
- Also suitable for wall-mounting
- Works with 4Ω, 6Ω and 8Ω speakers
- Speaker screw terminals handle wire sizes from 24 to 12 gauge
- 15W RMS per channel @ 4Ω

PR01328 01458301

STEREO AUDIO POWER AMPLIFIER

STEREO AUDIO POWER AMPLIFIER WITH SPEAKER VOLUME CONTROL

- 15W output
- Class D power amplifier
- Speaker protection circuit
- Screw terminals handle wire sizes from 24 to 12 gauge



AUDIO AMPLIFIER WALL PLATE



- To speaker screw terminals handle wire sizes from 24 to 12 gauge

PR01328K 01458307 STEREO AUDIO POWER AMP WITH SPEAKER VOLUME CONTROL

PR01328WP 01458303 AUDIO AMPLIFIER WALL PLATE

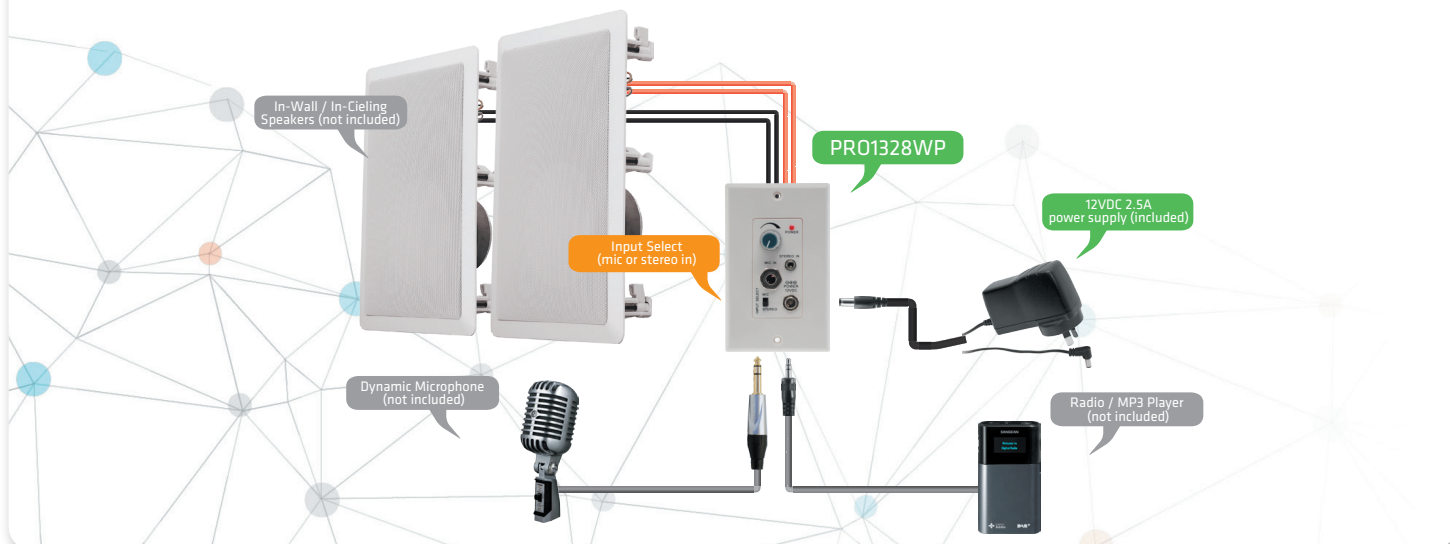

BLUETOOTH AMP



Use the PRO1351 to power in-ceiling speakers with the audio from any Bluetooth enabled device.

- Bluetooth wireless audio receiver built-in
- Switch between Bluetooth or 3.5mm (line) inputs
- Compact design
- Volume control
- Suitable for 4Ω, 6Ω and 8Ω speakers
- 15W RMS per channel @ 4Ω
- Includes Speaker Protection circuit

 PRO1351	01458312	BLUETOOTH AUDIO POWER AMP
 PRO1351WP	01458314	BLUETOOTH WALL PLATE AMP

BLUETOOTH MUSIC TRANSCEIVER



- No app or driver needed
- Noise reduction and echo cancellation
- Multi-band equalizer configuration
- Supports voice prompts
- Watch TV using your wireless Bluetooth headphones

PRO1398	39894382	BLUETOOTH MUSIC TRANSCEIVER
----------------	----------	-----------------------------

BLUETOOTH RECEIVER



Lose the wires without compromising audio quality or having to upgrade your audio system!

- Incorporates the Apt-X codec for exceptionally high CD quality wireless performance
- Dual simultaneous digital & analogue output
- S/PDIF Optical output
- 3.5mm analogue stereo output
- Low 70ms latency
- Low SNR: >100dB
- High level output: 2V rms

BMR3X	39894385	BLUETOOTH MUSIC RECEIVER
--------------	----------	--------------------------

IR DISTRIBUTION HUB

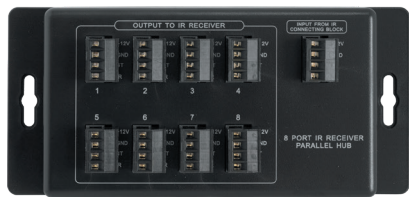

- Distribute infrared signal from an IR repeater (eg PRO1183) to up to eight receivers
- Large detachable terminal block (supplied) for quick and easy installation in structured wiring cabinet

PRO1256 39894134 8-PORT IR RECEIVER PARALLEL

IR REPEATER KIT



Connects IR receivers, power supply and emitters together to interface the IR system to the audio/ video components.



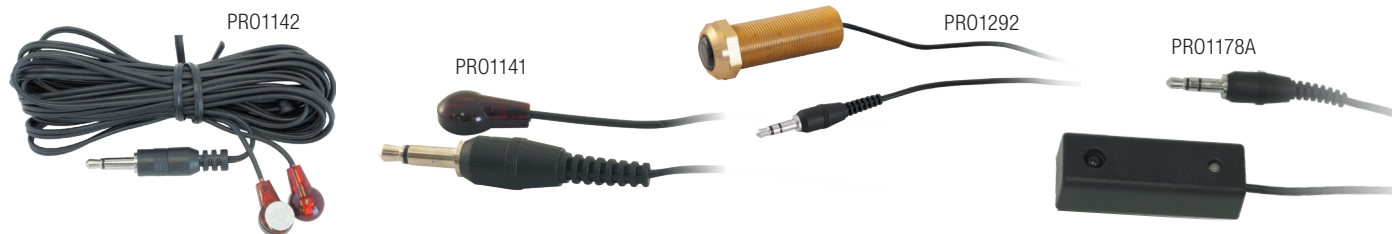

- Six emitter output connections
- Convenient IR confirmation LED
- Status power receptacle with LED indicator
- Compact size for mounting near audio equipment

PRO1183 37168730 IR REPEATER KIT

IR EMITTERS & TARGETS



Control devices from the output on your IR distribution module.

	PRO1142	37168732	DUAL IR EMITTER
	PRO1141	37168733	SINGLE IR EMITTER
	PRO1292	37168805	IR RECEIVER TUBE
	PRO1178A	37168734	SURFACE MOUNT IR RECEIVER

KORDZ IR70C IR WALL PLATE, TESTED TO WORK PERFECTLY WITH ALL IR SIGNALS INCLUDING FOXTEL.

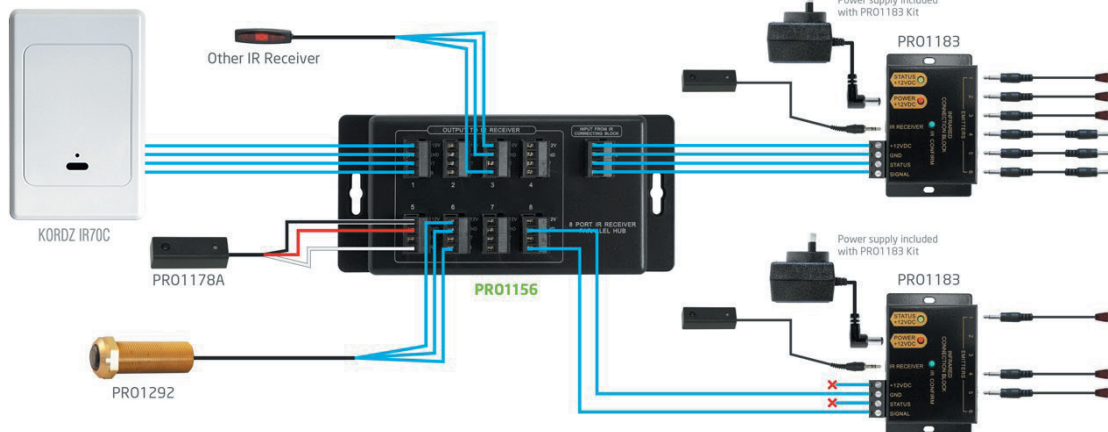

WIRELESS IR REPEATER SYSTEM

IR REMOTE EXTENDERS



Compatible with all universal full band carrier frequency infrared remote.

- Better IR receive sensitivity (distance), over 7 metres
- 915MHz RF technology to ignore current 433MHz RF-interference
- Digital encrypted function ensures safety and reliability
- Long range 915MHz



PRO1369 37168708 WIRELESS IR REPEATER SYSTEM

PRO1369SPT 37168706 SPARE TRANSMITTER FOR PRO1369

IR OVER RF EXTENDER



The Pro2 IRE12 transmitter takes the standard IR signal from your existing remote controls and converts it to the more powerful and reliable RF frequency which can pass through walls and objects!

- Maximum range: 50m line-of-sight
- 433.92MHz operating frequency
- Compatible with Foxtel iQ2/iQ3



MAIN ROOM

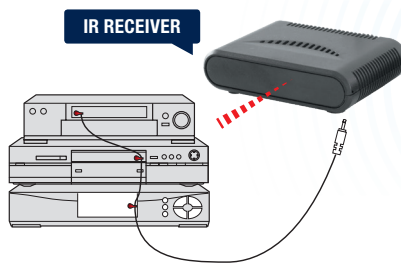

ROOM 1



IRE12 37169700 Kit

IR REMOTE CONTROL EXTENDER

IRE12SPT 37169702 Spare IR transmitter

SPARE IR TRANSMITTER FOR IRE12

IR RECEIVER ADAPTOR



Extend your IR control system with IR receiver adaptor.

- Easy to install
- Easily connect IR receivers to UTP cable
- Spring-clamp terminal block
- Wire range: 20-26AWG

PRO1294B 37168807 IR RECEIVER ADAPTOR

COMPACT IR REPEATER KIT



Hide your AV equipment in a cupboard or rack without losing the ability to control them with their remote controls.

- Quick and simple installation
- Four amplified emitter output connections
- Convenient IR confirmation LED
- Compact size for mounting near equipment
- IR receiver and emitters supplied
- Compatible with Foxtel iQ2/iQ3



PRO1326 37168700 COMPACT IR REPEATER KIT

PRO1330 37168702 TUBE IR TARGET FOR PRO1326

IR OVER COAXIAL

This kit allows IR signals to be inserted onto a coax cable in one location and extracted from coax on another location.

- Creates an IR system with existing wiring
- Powers up to 4x IR receivers with one power supply
- Quick and easy installation

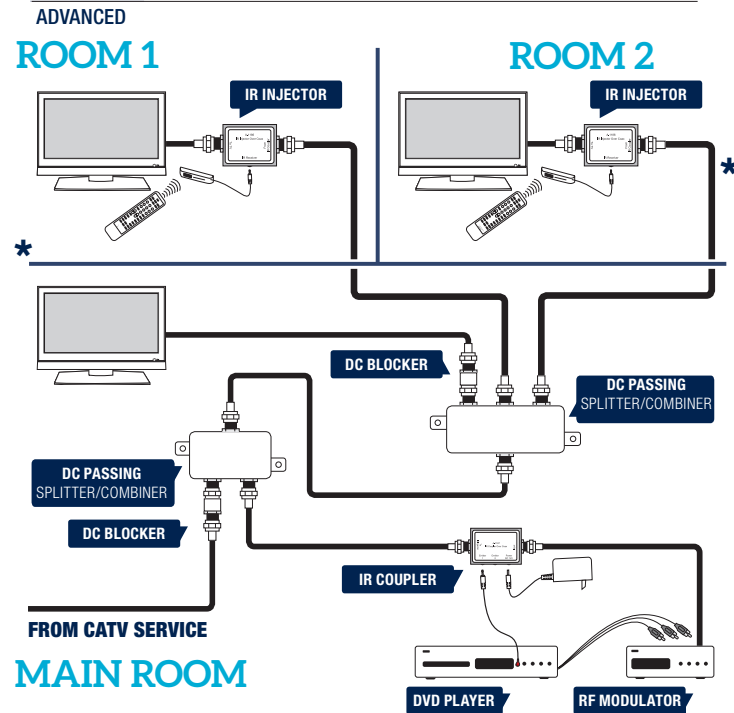
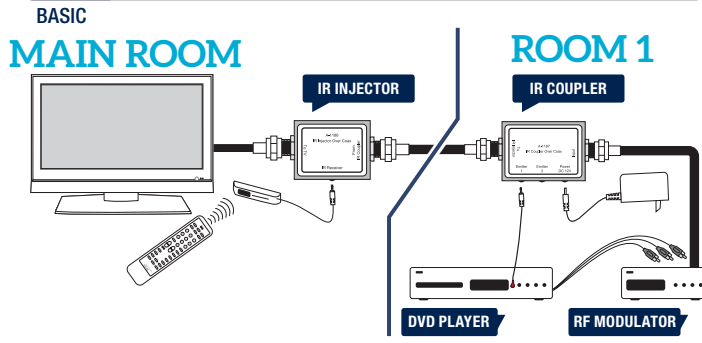

* Standard splitter/combiners have diodes, so voltage can only flow in one direction. We recommend using Channel Plus splitter combiners (model 2512 & 2514). These have been tested and confirmed to work with the Pro2 Pro1188. Secondly, we recommend the use of DC blockers at the TV inputs. This prevents voltage leakage from interfering with IR signal.

	PRO1188A	37168736	Kit	IR OVER COAX SYSTEM
	PRO1188AS	37168737	Spare receiver	SPARE RECEIVER FOR PRO1188A

6M IR EXTENSION LEAD



A 6 metre male to female cable for extending IR emitters and/or IR sensors with 3.5mm connectors.

This three-conductor cable has a 3.5mm male and 3.5mm female plug moulded onto a high quality cable.

PRO1297	37168815	6M IR EXTENSION LEAD
----------------	----------	----------------------

IR REPEATER WALL PLATES

IR REMOTE EXTENDERS



IR repeater wall plate kit connects the IR connecting block, IR receiver, IR emitter, and power supply together to interface the IR system to Audio/Video components.

- Three emitter output connections
- Convenient IR confirmation LED
- Status power connector with LED indicator

PRO1255

37168731

PRO2 IR REPEATER WALL PLATES



SPEAKER ATTENUATORS

100V/100W PA VOLUME CONTROL



- Audio power handling: 100 Watts RMS/channel
- Frequency: from 20Hz to 20kHz
- Attenuation: 12 positions control
- Wire connector type: screw type, wire range from 14AWG to 22AWG

PRO1075 39894038 100V/100W PA VOLUME CONTROL

VOLUME CONTROLLER



Volume control wall plates for low impedance speakers (4Ω to 8Ω).

IMPEDANCE MATCHING IR STYLE

	PRODUCT CODE	IMPEDANCE MATCHING	IR	STYLE	DESCRIPTION
	PRO1191	39894062	6-Step	4 / 6 / 8Ω	SUITS CLIPSAL 60W VOLUME ATTENUATOR
	PRO1163P	39894063	12-Step	1x / 2x / 4x / 8x	SUITS CLIPSAL 100W VOLUME ATTENUATOR
	PRO1161	39894060	12-Step	1x / 2x / 4x / 8x •	SUITS DECORA 100W VOLUME WITH IR

SPEAKER DISTRIBUTION HUB

SPEAKER DISTRIBUTION



8-Way speaker hub for use with parallel volume controls.

- Enables volume control in up to 8 rooms
- Light weight
- Screw terminals handle wire sizes from 24 to 12 gauge
- Wall mountable
- Small size and compact
- Requires the use of impedance-matching volume controls, like the above PRO1163P

PRO1257 39894138 8-WAY SPEAKER HUB

A, B OR A+B SPEAKER SELECTOR

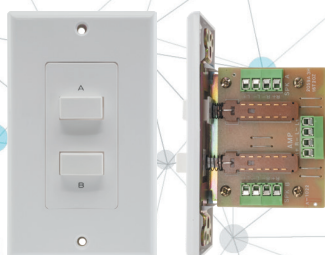

Decora-style Speaker Selector Wallplate.

- Switch between 2x speaker pairs or both simultaneously
- A / B / A+B Selector
- Push-type toggle switches
- Power handling: 100W Max
- Screw-type wire terminals

PRO1022 39894142 A, B OR A+B SPEAKER SELECTOR

2 WAY STEREO SPEAKER SWITCH



1 input to 2 outputs 2 way stereo speaker switch.

- Select Speaker Set A, B or A+B
- 10 Watts per channel
- Designed with non-shorting selector switch
- Screw terminals for amplifier input

PRO1001 39894123 2 WAY STEREO SPEAKER SWITCH

2 WAY SPEAKER SELECTOR/ SWITCH



Controls two pairs of speakers. The SPS2A is fitted with separate volume controls, speaker on/off, and speaker protection on/off switches.

- 50 Watts RMS per channel
- Attenuation (Volume): 10-position volume control
- Channel separation at 1kHz: 38dB normal
- Cross talk between channels at 1kHz: 50dB normal
- Impedance matching for 4Ω or 8Ω speakers

SPS2A 39894125 2 WAY SPEAKER SELECTOR/ SWITCH

4 & 6 WAY SPEAKER SELECTORS



These speaker selectors have been designed to let you add additional speakers around your home or office and turn them on without purchasing additional amplifiers.

- Left and right "commons" are isolated to work with all types of amplifiers
- Protection for amplifier and unit
- Small size to fit with any system
- No power required for operation
- Connects to any receiver or amplifier
- Can handle up to 100 watts amplifier power with unique protection circuitry
- No impedance matching

SPS4 39894110 4 WAY SPEAKER SELECTOR

SPS6 39894112 6 WAY SPEAKER SELECTOR



CABLE & CABLE ACCESSORIES

- 31 STEREO LEADS
- 32-33 AUDIO LEADS
- 34-46 COMPUTER LEADS
- 47 TV FLYLEADS
- 48-53 VIDEO LEADS

STEREO LEADS

3.5MM SLIM STEREO PLUG TO PLUG

GOLD
PLATED CONNECTORS



0.5M	LA1030	27311030
1M	LA1031	27311031
2M	LA1033	27311033

- High quality cable suitable for home cinema and digital stereo Hi-Fi systems, using high quality gold plated ends

3.5MM PLUG TO SOCKET STEREO EXTENSION LEAD

GOLD
PLATED CONNECTORS



2M	LA1063	27311063
5M	LA1065	27311065

- 3.5mm stereo plug to 3.5mm stereo socket
- 28AWG, OD=2.8*5.6mm

3.5MM STEREO LEADS

GOLD
PLATED CONNECTORS

- Black molding
- 28AWG, OD=2.8*5.6mm
- PVC jacket



3M	LA1035	27311035
5M	LA1039	27311039
10M	LA1042	27311042

15M	LA1044	27311044
20M	LA1045	27311045

5M STEREO EXTENSION LEAD



- 3.5mm headphone socket on one end and 6.3mm stereo plug on the other

LA1067 27311067

2M MONO 3.5MM PLUG TO RCA

GOLD
PLATED CONNECTORS



LA1081 27311081

1M STEREO 3.5MM PLUG TO PLUG

GOLD
PLATED CONNECTORS



LA1092 27311092

- Shielded PVC jacketed cable

PREMIUM STEREO LEADS

GOLD
PLATED CONNECTORS

- 2x RCA Plugs to Plugs
- Stereo Audio Left and Right (White & Red) interconnects
- Crystal clear transparent jacket
- SPC braid, double shielding
- Rubber grip
- All metal shielded plugs



Ideal interlink between A/V components in Hi-Fi stereo, Home Theatre, Video systems, and in-Car systems.

- 2x RCA to 2x RCA

1.5M	HLA8050	27318050
5M	LH0328	27330328

SPC RCA STEREO AUDIO LEAD

STEREO RCA LEAD WITH OFC

2M PREMIUM STEREO LEAD

GOLD
PLATED CONNECTORS



- 3.5m stereo plug to plug
- Assembled pearl chrome-plated metal shell

HLA8080 27318080

2X RCA STEREO LEADS

GOLD
PLATED CONNECTORS

- 26AWG, OD=3.0/3.0mm
- PVC jacket

0.3M	LA3013	27313013	5M	LA3033	27313033
1M	LA3015	27313015	10M	LA3035	27313035
2M*	LA3017	27313017	15M	LA3037	27313037
3M	LA3020	27313020	20M	LA3038	27313038



*2m not gold plated

3.5MM PLUG TO 2X RCA LEAD

GOLD
PLATED CONNECTORS

- Ideal for connecting portable audio devices with a 3.5mm output to an amp with RCA inputs

0.3M	LA1050	27311050	5M	LA1055	27311055
1M	LA1051	27311051	10M	LA1057	27311057
2M	LA1052	27311052	15M	LA1059	27311059
3M	LA1053	27311053	20M	LA1061	27311061



RCA TO 2X RCA SOCKET LEAD

GOLD
PLATED CONNECTORS



- Ideal for converting Stereo RCA Audio Leads into a single Mono RCA Audio Lead

0.3M	LA3082	27313082
------	---------------	----------

RCA TO 2X RCA PLUG LEAD

GOLD
PLATED CONNECTORS



- RCA plug to 2x RCA plugs AV lead

2M	LA3097	27313097
5M	LA3098	27313098

3.5MM SOCKET TO 2X RCA

GOLD
PLATED CONNECTORS



- 3.5mm stereo socket to two RCA sockets

0.3M	LA1048	27311048
------	---------------	----------

RIGHT ANGLE RCA STEREO LEAD

GOLD
PLATED CONNECTORS



- 26AWG, OD=3.0/3.0mm
- PVC jacket

2M	LA3041	27313041
----	---------------	----------

4-WAY RCA LEAD

- 4x RCA Plugs to 4x RCA Plugs
- Nickel plated connectors
- Black molding
- Length: 2m

LA3049	27313049
---------------	----------



XLR EXTENSION LEAD



3 pin Canon type Socket to 6.3mm shielded phone plug.

	10M	LA8000	27318000	XLR EXTENSION LEAD
	5M	LA8012	27318012	XLR SOCKET TO 6.3MM PLUG

PRO AUDIO LEADS

SPEAKON EXTENSION LEAD



Precision formulated, audiophile-grade, polyethylene dielectric material for maximum harmonic detail and low loss audio grade 99.99% pure oxygen-free copper conductors for maximum sound quality.

	2M	HLA8070	27318070	SPEAKON PLUG TO XLR PLUG
	2M	HLA8073	27318073	SPEAKON PLUG TO SOCKET
	2M	HLA8076	27318076	SPEAKON SOCKET TO SOCKET

AV LEADS

GOLD
PLATED CONNECTORS

- 3x RCA Plugs to 3x RCA Plugs (Yellow, Red & White)
- Yellow video lead is RG59



0.3M	LV1002	27471002	5M	LV1110	27471110
1M	LV1004	27471004	10M	LV1115	27471115
2M	LV1005	27471005	15M	LV1117	27471117
3M	LV1006	27471006	20M	LV1120	27471120

3.5MM 4-CONTACT TO 3X RCA

- Ideal for connecting your video camera to your TV, PVR or amplifier
- Nickel plated connectors
- Length: 2m



LA1077	27311077	3.5MM PLUG - 3 RCA PLUGS
---------------	----------	--------------------------

COMPOSITE AV

STEREO RCA EXTENSION LEAD 2X RCA PLUG TO 2X RCA SOCKET

GENERAL

GOLD
PLATED CONNECTORS

- 2x RCA Plugs to 2x RCA sockets with Individually shielded cable

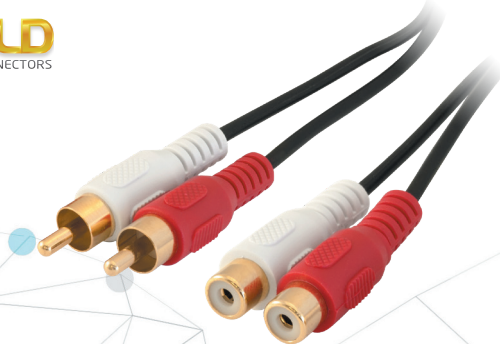

0.3M	LA3061	27313061	2 X RCA PLUGS TO 2X RCA SOCKETS
1M	LA3063	27313063	2 X RCA PLUGS TO 2X RCA SOCKETS

PREMIUM TOSLINK LEAD

TOSLINK LEADS

GOLD
PLATED CONNECTORS

- High grade optical cable for audio
- Double protected, super flexible cable
- Overall Diameter: 6mm



0.5M	LA0469	27330469	5M	LA0474	27330474
1M	LA0470	27330470	10M	LA0477	27330477
2M	LA0471	27330471	15M	LA0478	27330478
3M	LA0473	27330473	20M	LA0480	27330480

CAT5E PATCH LEADS

CAT5 PATCH



Moulded CAT5e patch cables provide the ultimate in reliability and can stand up to almost anything that comes their way.

- RJ45 Plugs
- 100Mbps data rate
- Unshielded 24-gauge twisted pair
- 4-Pairs (stranded conductors)



0.5M	LC7104B 27727104	LC7138G 27727138	LC7230W 27727230	LC7148Y 27727148	
1M	LC7106B 27727106	LC7139G 27727139	LC7231W 27727231	LC7149Y 27727149	
2M	LC7112B 27727112	LC7140G 27727140	LC7232W 27727232	LC7150Y 27727150	LC71600R 27727160
3M	LC7114B 27727114	LC7141G 27727141	LC7233W 27727233	LC7151Y 27727151	
5M	LC7118B 27727118	LC7142G 27727142	LC7234W 27727234	LC7152Y 27727152	
10M	LC7122B 27727122	LC7143G 27727143	LC7235W 27727235	LC7153Y 27727153	
15M	LC7125B 27727125	LC7144G 27727144	LC7236W 27727236	LC7154Y 27727154	
20M	LC7127B 27727127	LC7145G 27727145	LC7237W 27727237	LC7155Y 27727155	
30M	LC7100B 27727100				
40M	LC7102B 27727102				

CROSSOVER

10M CAT6 CROSSOVER LEAD



- RJ45 male-to-male connectors
- Stranded copper conductors for flexibility
- Fitted with flush injection moulded cable boots to prevent flaring of cables

LC6915 27726915

CAT6A PATCH LEADS

CAT6/6A PATCH

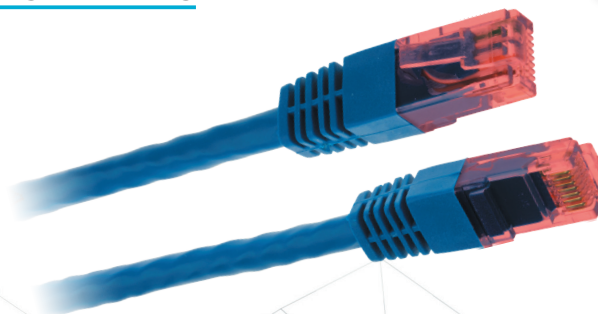

CAT6A cables have been designed to operate up to 10Gbps speeds, 10x better than CAT6 cables.

- Features RJ45 plug-to-plug connectors
- Quality cable material
- Moulded strain relief
- Low profile flush moulded boots

0.5M	LC6500B	27726500	3M	LC6506B	27726506	15M	LC6514B	27726514
1M	LC6502B	27726502	5M	LC6508B	27726508	20M	LC6516B	27726516
2M	LC6504B	27726504	10M	LC6512B	27726512			

CAT6/6A PATCH

CAT6 PATCH LEADS



CAT6 Patch Leads with moulded strain relief. Features RJ45 plug-to-plug connectors and supplied fitted with flush injection moulded cable boots to prevent flaring of cables.

- Quality cable material
- Moulded strain relief
- Low profile flush moulded boots
- Available Colours: Black, Blue, Green, White & Yellow



0.5m	LC7500BK 27727500	LC6600B 27726600	LC6628R 27726628	LC6654G 27726654	LC6735W 27726735	LC6681Y 27726681
1m	LC7502BK 27727502	LC6603B 27726603	LC6630R 27726630	LC6657G 27726657	LC6738W 27726738	LC6684Y 27726684
2m	LC7504BK 27727504	LC6606B 27726606	LC6633R 27726633	LC6660G 27726660	LC6741W 27726741	LC6687Y 27726687
3m	LC7506BK 27727506	LC6609B 27726609	LC6636R 27726636	LC6663G 27726663	LC6744W 27726744	LC6690Y 27726690
5m	LC7508BK 27727508	LC6612B 27726612	LC6639R 27726639	LC6666G 27726666	LC6747W 27726747	LC6693Y 27726693
10m	LC7510BK 27727510	LC6615B 27726615	LC6642R 27726642	LC6669G 27726669	LC6750W 27726750	LC6696Y 27726696
15m	LC7512BK 27727512	LC6618B 27726618	LC6645R 27726645	LC6672G 27726672	LC6753W 27726753	LC6699Y 27726699
20m	LC7514BK 27727514	LC6621B 27726621	LC6648R 27726648	LC6675G 27726675	LC6756W 27726756	LC6702Y 27726702
30m		LC6623B 27726623				
40m		LC6625B 27726625				

CAT6A PATCH SHIELDED

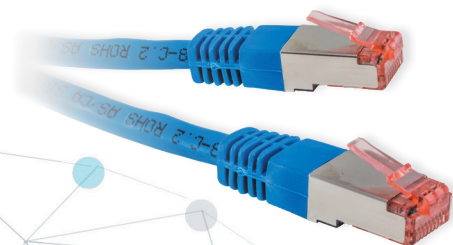

Why use shielded cable? Depending on the environment where network cable is run, it may have a large amount of EMI (Electro-Magnetic Interference). Although CAT6a cables have improved cable twist to handle gigabit Ethernet and reject noise, this by itself is not enough for environments that have high EMI. Using a shielded CAT6a cable will help in these high EMI installations.

0.5m	LC7520BL	27727520	10m	LC7530BL	27727530
1m	LC7522BL	27727522	15m	LC7532BL	27727532
2m	LC7524BL	27727524	20m	LC7534BL	27727534
3m	LC7526BL	27727526	30m	LC7536BL	27727536
5m	LC7528BL	27727528	40m	LC7538BL	27727538

Pro2 fibre patch leads ensure the performance and reliability of servers, storage, and network switches and are built using the highest-quality fibre cable and connectors.

APPLICATIONS:

- Gigabit Ethernet
- Active Device Termination
- Premise Installations
- Telecommunication Networks
- Multimedia

FIBRE-CONNECTION TYPES

- LC - The LC connector features a small form factor and resembles the SC connector
- SC - The SC connector has a molded, plastic plug casing and a push/pull locking system
- ST - The ST connector uses a push-and-turn-to-lock system
- MTRJ -The MTRJ connector is a small form-factor connector with a square plastic casing that contains both fibre strands into a single polymer ferrule

SINGLE MODE

Singlemode fibre optic cable has a small core and only one pathway of light. With only a single wavelength of light passing through its core, singlemode realigns the light toward the center of the core instead of simply bouncing it off the edge of the core as with multimode. Singlemode is typically used in long-haul network connections spread out over extended areas-- longer than a few miles. For example, telcos use it for connections between switching offices. Singlemode cable features a 9-micron glass core.

DUPLEX MODE

Duplex cable consists of two fibres, usually in a zipcord (side-by-side) style. Use duplex multimode or singlemode fibre optic cable for applications that require simultaneous, bi-directional data transfer. Workstations, fibre switches and servers, fibre modems, and similar hardware require duplex cable. Duplex fibre is available in singlemode and multimode.

DUPLEX MODE FIBRE PATCH LEAD

- OD 2.0MM DUPLEX 50/125

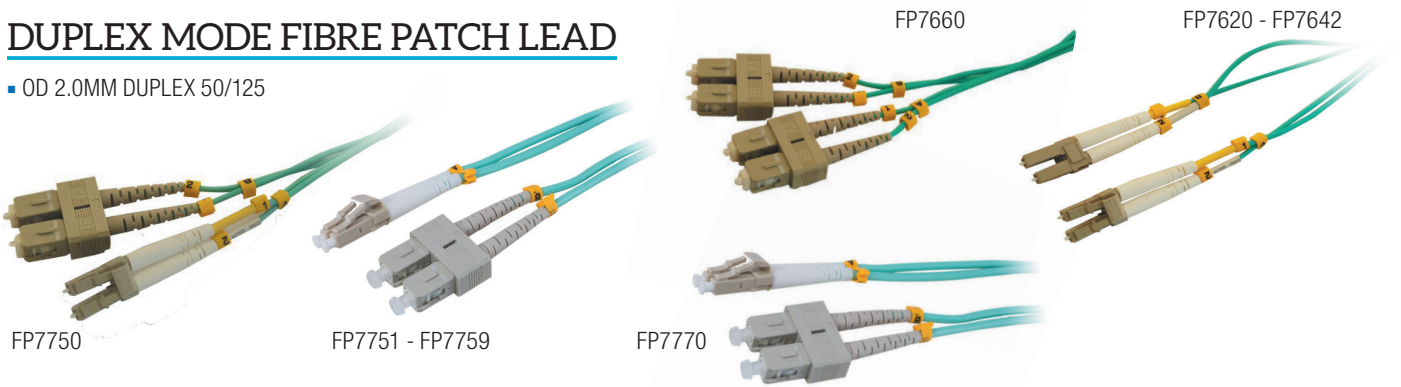

	2M	FP7750	27727750	OM3	LC-SC CONNECTOR
	3M	FP7751	27727751	OM3	LC-SC CONNECTOR
	5M	FP7753	27727753	OM3	LC-SC CONNECTOR
	10M	FP7755	27727755	OM3	LC-SC CONNECTOR
	15M	FP7757	27727757	OM3	LC-SC CONNECTOR
	20M	FP7759	27727759	OM3	LC-SC CONNECTOR
	2M	FP7660	27727660	OM3	SC-SC CONNECTOR

	2M	FP7620	27727620	OM3	LC-LC CONNECTOR
	3M	FP7622	27727622	OM3	LC-LC CONNECTOR
	5M	FP7624	27727624	OM3	LC-LC CONNECTOR
	2M	FP7640	27727640	OM4	LC-LC CONNECTOR
	3M	FP7642	27727642	OM4	LC-LC CONNECTOR
	2M	FP7770	27727770	OM4	LC-SC CONNECTOR

MINIMUM REACH OF ETHERNET VARIANTS OVER DUPLEX MODE FIBER

Category	Minimum modal bandwidth 850 / 953 / 1300 nm	Fast Ethernet 100BASE-FX	1Gb (1000 Mb) Ethernet 1000BASE-SX	1Gb (1000 Mb) Ethernet 1000BASE-LX	10Gb Ethernet 10GBASE-SR	40Gb Ethernet 40GBASE-SWDM4	40Gb Ethernet 40GBASE-SR4	100Gb Ethernet 100GBASE-SR10
OM3 (50/125) *Laser Optimized*	1500 / - / 500MHz-km	2000m	550m	550m (no mode-conditioning patch cord should be used)	300m	240m[17] Duplex LC	100m (330m QSFP+ eSR4)	100m
OM4 (50/125) *Laser Optimized*	3500 / - / 500MHz-km	2000m	550m	550m (no mode-conditioning patch cord should be used)	400m	350m[20] Duplex LC	150m (550m QSFP+ eSR4)	150m

FIBRE PATCH

SINGLE MODE FIBRE PATCH LEAD

■ DX 3.00mm LSZH

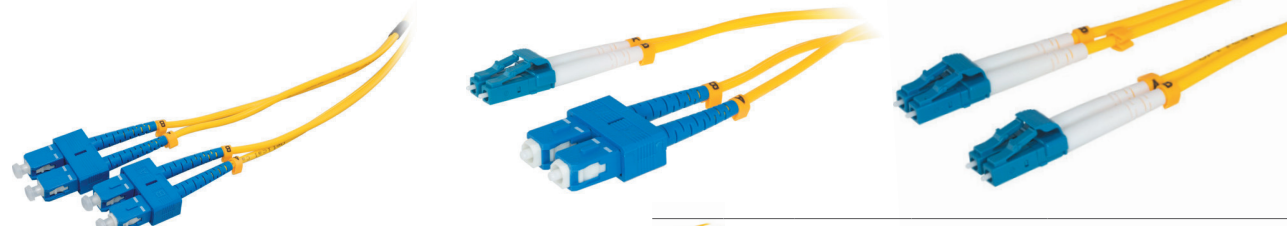

FP7600		FP7602		FP7604 - FP7618			
2M	FP7600	27727600	SC-SC CONNECTOR	1M	FP7618	27727618	LC-LC CONNECTOR
2M	FP7602	27727602	SC-LC CONNECTOR	2M	FP7604	27727604	LC-LC CONNECTOR
				3M	FP7606	27727606	LC-LC CONNECTOR
				5M	FP7608	27727608	LC-LC CONNECTOR

FIBRE CABLE ROLL

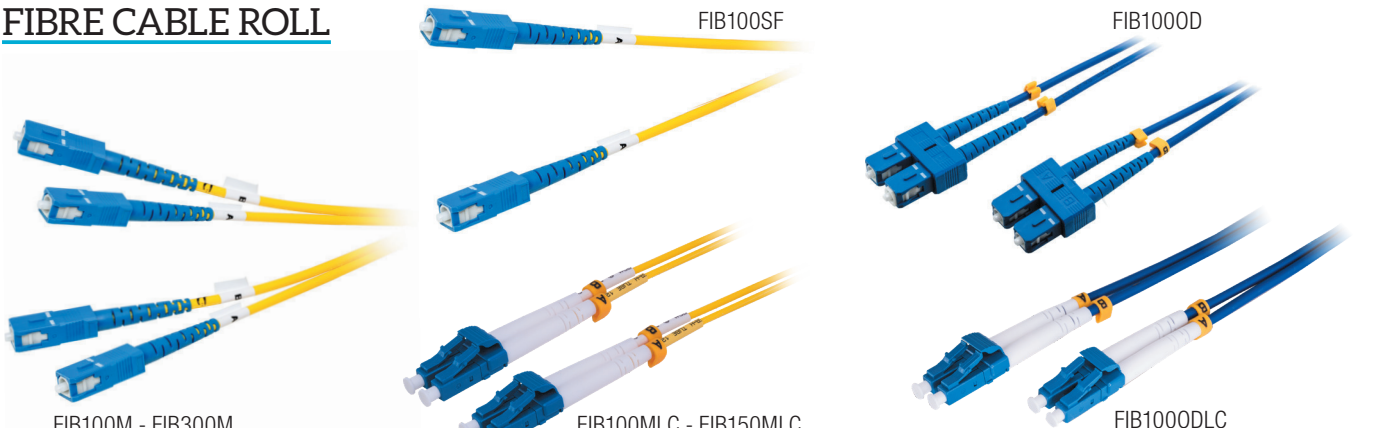

FIB100M - FIB300M FIB100SF FIB1000D

FIB100MLC - FIB150MLC FIB1000DLC

100M	FIB100M	05060860	SC-SC CONNECTOR - DUPLEX
150M	FIB150M	05060880	SC-SC CONNECTOR - DUPLEX
200M	FIB200M	05060900	SC-SC CONNECTOR - DUPLEX
250M	FIB250M	05060920	SC-SC CONNECTOR - DUPLEX
300M	FIB300M	05060960	SC-SC CONNECTOR - DUPLEX
100M	FIB100SF	05060700	SC-SC CONNECTOR - SINGLE
100M	FIB100MLC	05060870	LC-LC CONNECTOR - SINGLE
150M	FIB150MLC	05060890	LC-LC CONNECTOR - SINGLE
100M	FIB1000D	05060750	SC-SC CONNECTOR - SINGLE - OUTDOOR
100M	FIB1000DLC	05060770	LC-LC CONNECTOR - SINGLE - OUTDOOR





USB

USB EXTENSION LEADS



2M	LC7190	27727190	USB-A PLUG TO USB-A SOCKET
5M	LC7215	27727215	USB-A PLUG TO USB-A SOCKET
5M	LC7218	27727218	ACTIVE USB EXTENSION LEAD

POWER INJECTION LEAD



Perfect for use with the USB Power Injection Lead, or simply to supply power to devices that require 5V (using a standard 2.1mm DC socket) from a standard USB Power Pack.

0.8M	LC7224	27727224	1.3MM DC PLUG	RETRACTABLE USB TO DC
0.8M	LC7225	27727225	2.1MM DC PLUG	

USB LEADS



	25cm	LC7185	27727185	USB A PLUG TO USB A SOCKET
	2m	LC7186	27727186	USB-A PLUG TO MINI USB-B PLUG
	1m	LC7188	27727188	USB-A PLUG TO USB-A PLUG
	2m	LC7189	27727189	
	5m	LC7195	27727195	
	2m	LC7200	27727200	USB-A PLUG TO USB-B PLUG
	5m	LC7203	27727203	
	3m	LC7210	27727210	
	2m	LC7241	27727241	USB-A PLUG TO MICRO USB-B PLUG
	2m	LC7243	27727243	TRANSPARENT USB-A PLUG TO MICRO USB-B PLUG

1M USB3.0 LEADS



- Nickel plated connectors
- Version: USB3.0



	LC7251	27727251	USB3.0 USB-A PLUG TO USB-A PLUG
	LC7256	27727256	USB3.0 USB-A PLUG TO USB-A SOCKET
	LC7261	27727261	USB3.0 USB-A PLUG TO USB-B PLUG
	LC7266	27727266	USB3.0 USB-A PLUG TO MICRO USB-B LEAD

2 IN 1 1M MICRO USB-B OTG LEAD



Use it as a standard USB to micro-USB lead or as a micro-USB to micro-USB OTG cable between your compatible Android phone and tablet!

LC7227	27727227	2 IN 1 MICRO USB-B OTG LEAD
---------------	----------	-----------------------------

TYPE C



	LC7805	27727805	1M USB-C TO USB3.0 PLUG
	LC7815	27727815	1M USB-C TO MICRO B
	LC7825	27727825	1M USB-C TO USB-C PLUG
	LC7807	27727807	2M USB-C TO USB3.0 PLUG
	LC7855	27727855	0.5M USB-C TO USB3.0 SOCKET
	LC7865	27727865	0.3M USB-C TO HDMI SOCKET

30CM USB POWER INJECTION LEAD



If your mobile device can't power your USB device via USB-OTG, then use the LC7222 to supply it with external power!

- Perfect for USB-OTG and higher current devices!
- Built-in capacitor for protecting devices and computer from noisy external power supplies
- Simply connect your 5VDC power supply to the 2.1mm DC Socket

LC7222 27727222

MICRO USB OTG ADAPTOR



- Connect external flash drives, keyboards, mice, and any other USB peripheral your mobile device supports!
- USB-OTG Cable suitable for mobile devices which feature USB-HOST

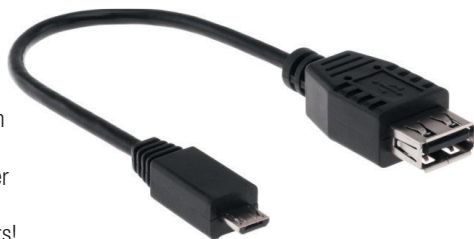

LC7245 27727245

45CM USB TO SERIAL (RS232)



- Provides PCs, notebook PCs and handheld computing devices using USB an external PnP RS232 port

USB-RS232 27727280

1.8M USB TO DB25 PRINTER CABLE

- USB 2.0 compliant
- Bi-directional parallel interface communication



USB-DB25 27727290

2M MINI DISPLAYPORT TO HDMI

GOLD
PLATED CONNECTORS



- Connects from a Mini-DisplayPort or Thunderbolt video output device to a HDMI screen or projector
- Transmit both audio and video signals
- Resolution capability of up to 1080p

LC6153 27726153

MINI DISPLAYPORT TO HDMI

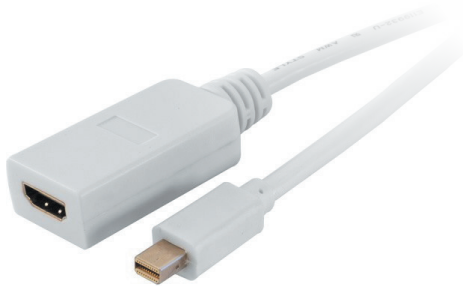

- RoHS compliant
- Mini DisplayPort 20-pin plug to HDMI 19-pin socket
- Nickel plated plug
- It can be used with MacBooks, iMac, Xserve servers, and 24-inch Apple Cinema Display. Also in Toshiba Satellite Pro S500, Tecra M11, A11, S11, HP Envy 14 and 17 notebooks

20CM LC6150 27726150

2M LC6152 27726152

2M MINI DISPLAYPORT TO DVI-I

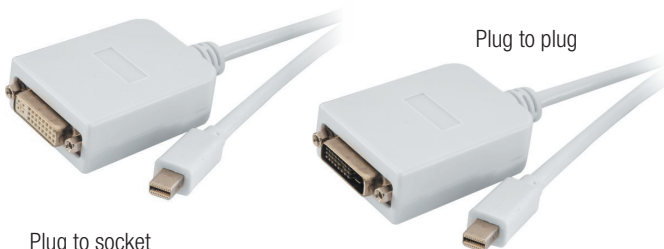

Plug to socket

Plug to plug

- Mini DisplayPort 20-pin plug to DVI 29-pin plug or socket
- Nickel plated plug
- Use with MacBooks, iMacs, Mac Mini, and Mac Pro desktops, and 24-inch Apple Cinema Display. Also in Toshiba Satellite Pro S500, Tecra M11, A11, S11, HP Envy 14 and 17 notebooks

LC6162 27726162 PLUG TO SOCKET

LC6163 27726163 PLUG TO PLUG

MINI DISPLAYPORT TO VGA



- Mini DisplayPort 20-pin plug to VGA HDB 15-pin socket
- Nickel plated plug
- Use with MacBooks, iMacs, Mac Mini, and Mac Pro desktops, and 24-inch Apple Cinema Display. Also in Toshiba Satellite Pro S500, Tecra M11, A11, S11, HP Envy 14 and 17 notebooks

20CM LC6170 27726170

2M LC6172 27726172

20CM MINI DISPLAYPORT TO DVI 29-PIN



- Nickel plated plug
- RoHS compliant

LC6160 27726160

2M MINI DISPLAYPORT LEAD



- Mini DisplayPort 20-pin plug to Mini DisplayPort 20-pin plug
- Nickel plated plug
- RoHS compliant

LC6190 27726190

DISPLAYPORT

2M DISPLAYPORT PLUG TO HDMI



The DisplayPort to HDMI adapter lets you connect a DisplayPort video source to a HDMI-enabled video display.

- Supports display resolutions up to 1920x1200
- Nickel plated plugs

LC6210 27726210

DISPLAYPORT TO DISPLAYPORT



- DisplayPort 20 pin plug to plug
- Transfer both audio and video
- 28AWG cable gauge
- Copper conductor

LC6216 27726216 2M

LC6218 27726218 3M

LC6220 27726220 5M

LC6225 27726225 10M

3.5MM AUDIO LINE OUT 30 PIN USB CABLE

IPHONE/IPAD

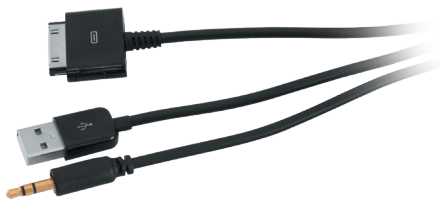

IPDAU 27727307

10CM IPOD SHUFFLE TO USB LEAD

Perfect for syncing and charging your iPod Shuffle via USB.



ISHUFFLE2USB 27727301

LIGHTNING TO HDMI ADAPTER LEAD

Mirror-casting IOS device to TV or Projector.

- 5V 1A USB power supply needed
- 8 pin lightning port to HDMI



8P2HDMI 30254400 IPHONE 5/6 IPAD 8 PIN TO HDMI

1M LIGHTNING TO USB LEAD

Made for
 iPod iPhone iPad

- Apple MFi certification guarantee
- Nylon-braided cable
- 1 metre in length
- 8 pin lightning plug to USB A plug



IPLC1GD 27727345

IPLC1SLV 27727347

IPLC1GRAY 27727349

COLOUR



STANDARD VGA LEADS



	2M	LC1000	27721000	M/M	HIGH DENSITY VGA PLUG TO PLUG LEAD
	2M	LC1010	27721010	M/F	HIGH DENSITY VGA PLUG TO SOCKET LEAD

VGA LEAD

This super VGA lead is known as the best in the industry as the 3 Coax + 9 wiring plug configuration, which can minimise the quality loss over long distances, plus two ferrite filters at both ends to reduce interference.

- 3 Coax + 9 wiring configuration
- Ferrite filters at both ends
- Ø8.5mm outer diameter (28AWG)
- Black dentate cable with PVC jacket



Can you spot the difference in quality?



Competitor A **Pro.2**

HD15 plug to HD15 plug

0.5M	LC1050	27721050	15M	LC1120	27721120
1M	LC1060	27721060	20M	LC1130	27721130
2M	LC1070	27721070	25M	LC1140	27721140
3M	LC1080	27721080	30M	LC1150	27721150
5M	LC1100	27721100	40M	LC1160	27721160
10M	LC1110	27721110			

VGA EXTENSION LEAD



HD15 plug to HD15 socket

1M	LC1210	27721210	15M	LC1270	27721270
2M	LC1220	27721220	20M	LC1280	27721280
3M	LC1230	27721230	25M	LC1290	27721290
5M	LC1250	27721250	30M	LC1300	27721300
7.5M	LC1255	27721255	40M	LC1310	27721310
10M	LC1260	27721260			

SLIM VGA LEADS

- 3+9 wiring configuration
- Ferrite filters at both ends
- Slim cable for maximum flexibility
- Our slim & flexible low loss coaxial (3 coax + 9 control wire) cables are ideal for short run applications (up to 5 metres)



2M	LC2010	27722010
3M	LC2012	27722012
5M	LC2025	27722025

VGA LEADS WITH 3.5MM STEREO AUDIO



2M	LC1370	27721370
3M	LC1380	27721380
5M	LC1400	27721400
10M	LC1410	27721410
15M	LC1400	27721420

INSTALLER VGA LEADS

This VGA lead is designed to pass through the wall easily as you only need to drill a DIN plug size hole on your wall instead of big VGA plug size hole.

- Ferrite filters at the end minimises interference
- HD15 plug to HD15 plug
- DIN13 Connector: Ø18.5mm



2M	LC1500	27721500	10M	LC1540	27721540
3M	LC1510	27721510	15M	LC1550	27721550
5M	LC1530	27721530			

SLIM VGA SOCKET TO SOCKET

- 3+9 wiring configuration
- Slim cable for maximum flexibility
- VGA Socket to VGA Socket



15cm	LC6098	27726098
------	---------------	----------

30CM VGA PLUG TO 3XRCA & VGA

GOLD
PLATED CONNECTORS



- High density VGA 15 pin plug to VGA socket and 3 RCA sockets; (blue, green, red)

LC6092	27726092
---------------	----------

30CM VGA PLUG TO 2X VGA SOCK

GOLD
PLATED CONNECTORS



- High density VGA 15 pin plug to 2x VGA sockets
- Includes transparent dust cover

LC6090	27726090
---------------	----------

30CM DVI-I PLUG TO VGA + DVI-I SOCKETS

GOLD
PLATED CONNECTORS



- DVI-I 29pin plug to DVI-I 29pin socket and HDB 15pin VGA socket

LC6094	27726094	DVI-I PLUG TO VGA + DVI-I
LC6096	27726096	DVI-I PLUG TO 2X VGA

DVI-D LEADS

GOLD
PLATED CONNECTORS



- DVI-D Dual Link cable
- Ferrite beads on both ends to minimise interference
- Gold Plated copper for lower contact resistance
- Foamed PE Insulation ensuring high speed propagation and low signal loss



DVI-D (Single Link)

0.3M	HLV0969	27330969	5M	HLV0976	27330976
1M	HLV0970	27330970	10M	HLV0979	27330979
2M	HLV0973	27330973	15M	HLV0980	27330980
3M	HLV0975	27330975			

HDMI TO DVI LEADS

GOLD
PLATED CONNECTORS

- 19 pin HDMI-A to DVI-D Dual Link cable
- Ferrite beads on both ends to minimise interference
- Foamed PE Insulation ensuring high speed propagation and low signal loss



0.3M	HLV0981	27330981	5M	HLV0989	27330989
1M	HLV0983	27330983	10M	HLV0991	27330991
2M	HLV0986	27330986	15M	HLV0993	27330993
3M	HLV0987	27330987			

HDMI TO VGA ADAPTOR LEAD

- Converts HDMI video to analog VGA video (no audio)
- Supports analog video output up to UXGA and 1080p
- Just plug and play



HV02 30251968

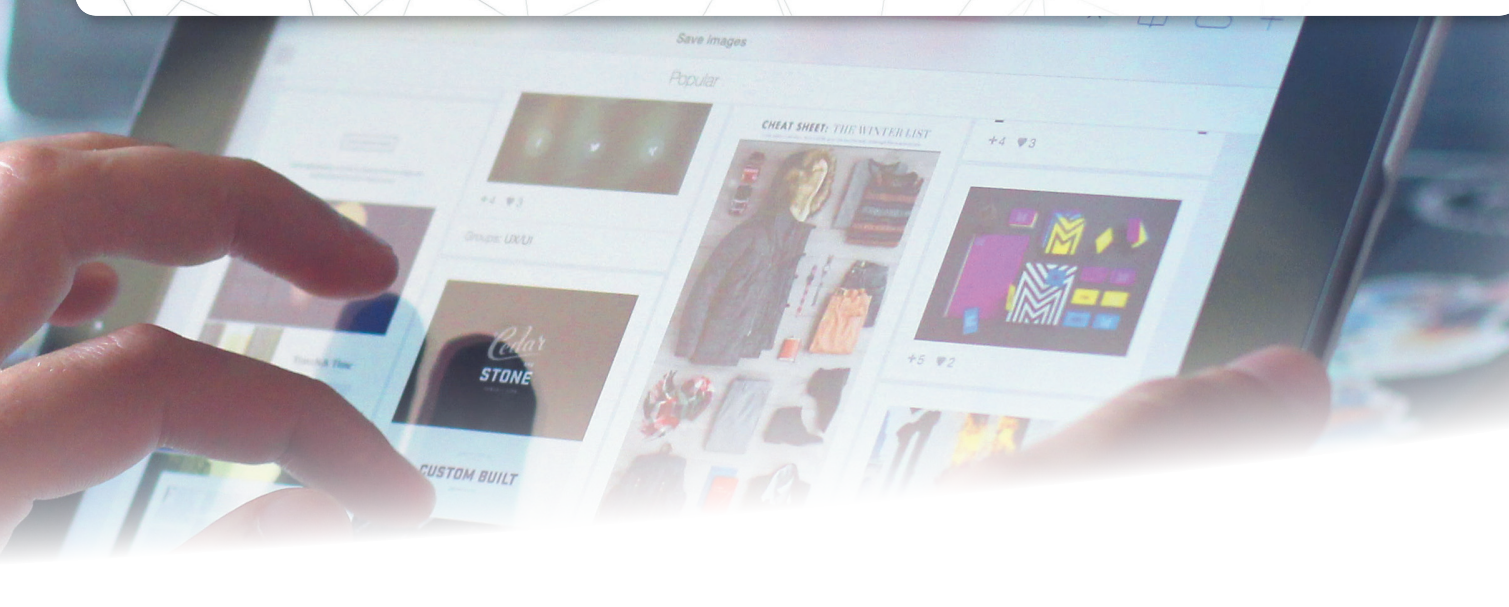

2M PS2 PLUG TO SOCKET LEAD

DIN

- 6 Pin Mini Din Plug to Socket
- Shielded lead

LC6037 27726037

45CM SATA LEAD

PC INTERNAL

Compatible with SATA I and SATA II.

SATA45 27727420

D-SUB LEADS

D RANGE

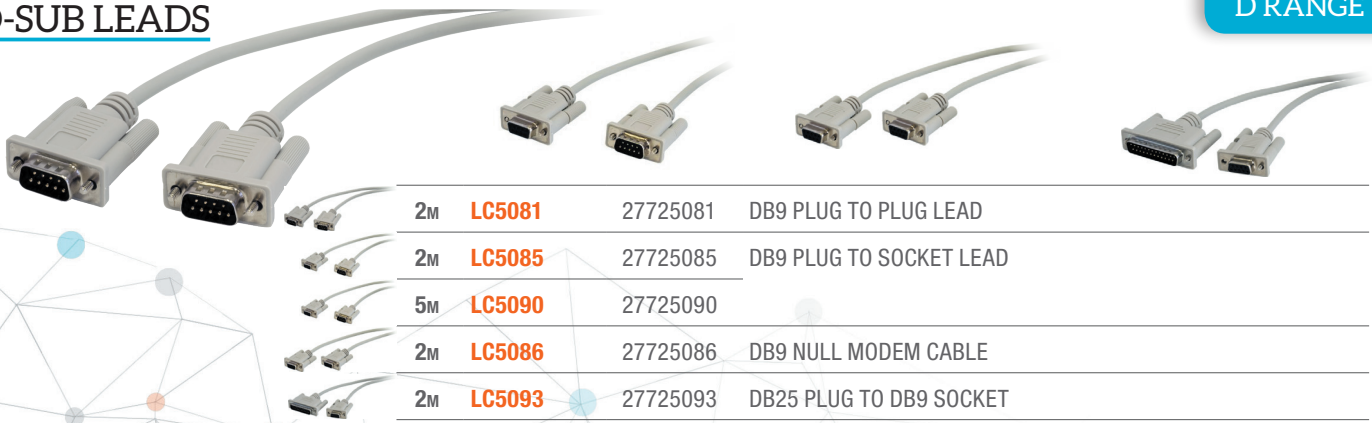

2M	LC5081	27725081	DB9 PLUG TO PLUG LEAD
2M	LC5085	27725085	DB9 PLUG TO SOCKET LEAD
5M	LC5090	27725090	
2M	LC5086	27725086	DB9 NULL MODEM CABLE
2M	LC5093	27725093	DB25 PLUG TO DB9 SOCKET

1.8M 21PIN SCART PLUG TO PLUG

SCART



For TV to Video interlinking using high quality shielded cable for recording and playback of audio and video signals.

- Pin to Pin shielded cable
- 21-pin SCART plug to 21-pin SCART plug
- Length: 1.8m

LV5124 27475124

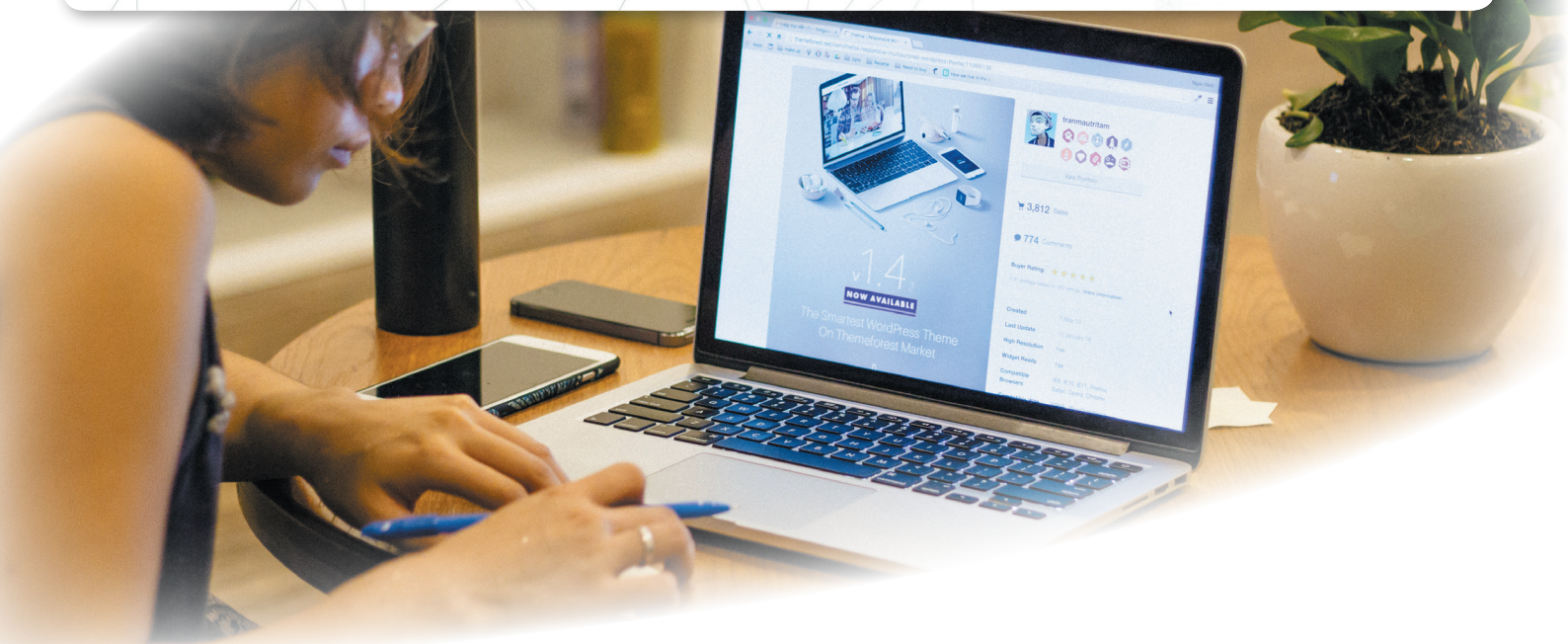

PAL - F TYPE

FLYLEADS



	0.3M	FL59Q-0.3FF	00771460	'F' TO 'F'	RG59	RG59QUAD 'F' TO 'F' LEAD
	0.5M	FL59Q-0.5PF	00771330	'F' TO PAL	RG59	RG59QUAD 'F' TO PAL LEAD
	1M	FL59Q-1PF	00771340			
	1.5M	FL59Q-1.5PF	00771350			
	2M	FL59Q-2PF	00771360			
	1.5M	FL6Q-1.5PF	00771860	'F' TO PAL	RG6	RG6QUAD 'F' TO PAL LEAD
	3M	FL6Q-3PF	00771880			

FLYLEAD COMPRESSION

This compression plug not only improves aesthetics for a cleaner install, but also adds strength, results in less snags when pulling

a cable from a bundle, and less crowding for improved air flow around equipment.



	0.5M	FL59Q-0.5CFF	00773010	RG59Q	'F'-TYPE PLUG TO 'F'-TYPE PLUG
	1M	FL59Q-1CFF	00773020		
	2M	FL59Q-2CFF	00773030		
	3M	FL6Q-3CFF	00773040	RG6Q	'F'-TYPE PLUG TO 'F'-TYPE PLUG
	5M	FL6Q-5CFF	00773050		
	10M	FL6Q-10CFF	00773060		
	15M	FL6Q-15CFF	00773070		

PAL - PAL

FLYLEADS



	0.5M	FL59Q-0.5PP	00771070	●	RG59Q	RG59QUAD PAL FLYLEAD
	1M	FL59Q-1PP	00771080	●		
	1.5M	FL59Q-1.5PP	00771090	●		
	2M	FL59Q-2PP	00771100	●		
	3M	FL59Q-3PP	00771110	●		
	5M	FL59Q-5PP	00771120	●		
	10M	FL59Q-10PP	00771130	●		
	0.5M	FL59Q-0.5PPW	00771140	○	RG59Q	RG59QUAD PAL FLYLEAD
	1M	FL59Q-1PPW	00771150	○		
	2M	FL59Q-2PPW	00771160	○		
	3M	FL59Q-3PPW	00771170	○		
	1.5M	FL6Q-1.5PP	00771610	●	RG6Q	RG6QUAD PAL FLYLEAD
	1.5M	FL6Q-1.5PPW	00771675	○	RG6Q	RG6QUAD PAL FLYLEAD

0.3M RG59QUAD EXTENSION LEAD

- Digital ready
- Quad shield coaxial 75Ω
- RG59 is generally preferred for fly-leads due to greater flexibility over RG6

EL59Q-0.3PP 00771200



RG59QUAD TV EXTENSION LEAD



TV FLYLEADS

	1M	EL59Q-1PP	00771210		3M	EL59Q-3PP	00771240
	1.5M	EL59Q-1.5PP	00771220		5M	EL59Q-5PP	00771250
	2M	EL59Q-2PP	00771230		10M	EL59Q-10PP	00771260

HDMI FLAT LEADS



FLAT DESIGN

With gold plated plugs and oxygen free copper conductors, the Contractor Series can deliver 4K Ultra Full HD video and HD audio with minimal loss or interference.

- Functional, flat, low-profile design!
- Supports 3D, 4K and Deep Colour formats
- Supports ARC, CEC and Ethernet over HDMI

	0.5M	HLVF0.5	27476000	0.5M HDMI CONTRACTOR SERIES
	1M	HLVF1	27476002	1M HDMI CONTRACTOR SERIES
	2M	HLVF2	27476003	2M HDMI CONTRACTOR SERIES
	3M	HLVF3	27476004	3M HDMI CONTRACTOR SERIES
	5M	HLVF5	27476006	5M HDMI CONTRACTOR SERIES

CONTRACTOR SERIES



With gold plated plugs and oxygen free copper conductors, the Contractor Series can deliver 4K Ultra Full HD video and HD audio with minimal loss or interference.

- Supports 3D (10m & 15m lengths), 4K (10m & 15m lengths) and Deep Colour formats
- Supports Ethernet over HDMI (10m & 15m lengths), ARC, and CEC

WITH BOOSTER

	10M	HLVR10	27476011		ROUND CONTRACTOR SERIES
	15M	HLVR15	27476016		
	20M	HLVR20	27476020		•
	30M	HLVR30	27476030		•
	40M	HLVR40	27476040		•

DESIGNER SERIES

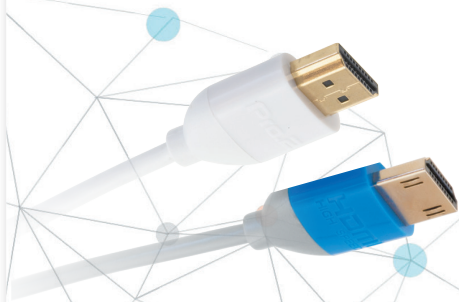

- Only 3.2mm diameter
- 1080p and 4K Ultra HD Compatible
- Advanced 7.1CH Surround Sound
- Full featured HDMI Audio Return Channel (ARC) and Consumer Electronics Control (CEC)

COLOUR

	0.5M	HLDS0.5M	27476550	●	SILVER/BLUE DESIGNER SERIES HDMI LEAD
	0.5M	HLDS0.5W	27476551	○	WHITE DESIGNER SERIES HDMI LEAD
	1M	HLDS1W	27476556	○	WHITE DESIGNER SERIES HDMI LEAD
	2M	HLDS2W	27476560	○	WHITE DESIGNER SERIES HDMI LEAD
	3M	HLDS3W	27476566	○	WHITE DESIGNER SERIES HDMI LEAD

EASY LOCK HDMI LEAD

 Video online

LIFE TIME WARRANTY!

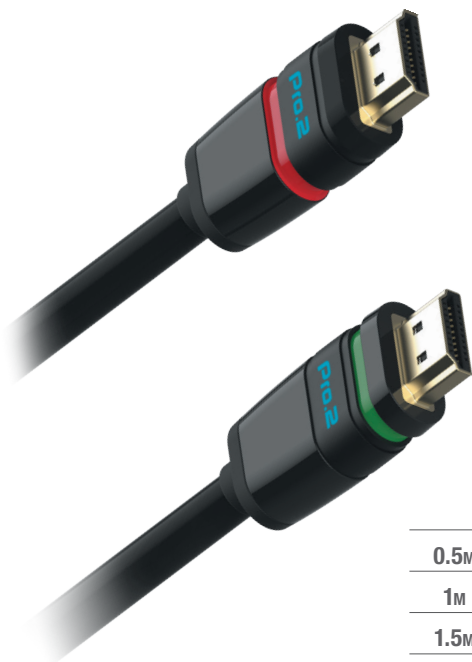

The unique and patented EasyLock HDMI locking cable can be used with ANY standard HDMI device to prevent accidental disconnection. Unlike other HDMI locking solutions, the EasyLock HDMI cables will work with any brand of TV, monitor, set top box, media player, switch, splitter, extender or wall plate.

- World's first ATC certified locking HDMI cable
- Supports HDMI 2.0 and HDMI 1.4
- Supports all the latest 4K Ultra HD TV's with resolution up to 3840 x 2160 (2160p)
- Green and Red colour indicators to show lock status
- 24k gold plated corrosion resistant connectors for maximum conductivity and low signal loss



0.5M	ELHH005	27475800	LOCKING CABLE HDMI2.0 4K
1M	ELHH010	27475801	
1.5M	ELHH015	27475802	
3M	ELHH030	27475804	
5M	ELHH050	27475805	
7.5M	ELHH075	27475806	
10M	ELHH100	27475807	

EASY LOCK DVI LEAD

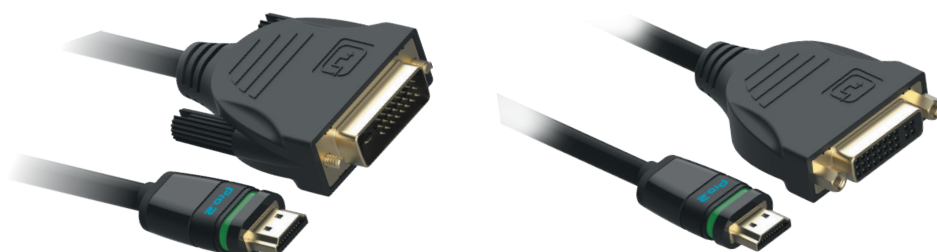

0.5M	ELHD005	27331250	EASY LOCK HDMI TO DVI LEAD
1M	ELHD010	27331251	
2M	ELHD020	27331252	
3M	ELHD030	27331253	
0.5M	ELHDS005	27331260	EASY LOCK HDMI-DVI SOCKET

EASY LOCK HDMI EXTENSION



0.5M	ELHHS005	27331170	EASY LOCK HDMI EXTENSION
1M	ELHHS010	27331171	
2M	ELHHS020	27331172	
3M	ELHHS030	27331173	

HDMI LEADS

0.5M HDMI EXTENSION LEAD

GOLD
PLATED CONNECTORS



- PVC jack
- 28AWG

HLV1145 27331145

2M MICRO HDMI TO HDMI A LEAD

GOLD
PLATED CONNECTORS



- High speed with Ethernet
- HDMI type A plug to HDMI type D (micro) plug

HLV1165 27331165

1M HDMI LEAD WITH SWIVEL PLUG

GOLD
PLATED CONNECTORS



- 28AWG
- With one swivel plug
- Length: 1m

HLV1150 27331150

0.3M HDMI PLUG TO 2X SOCKETS

GOLD
PLATED CONNECTORS



- HDMI 19 pin plug to 2x HDMI sockets
- Includes transparent dust cover

HLV1140 27331140

2M MINI HDMI TO HDMI A LEAD



Suitable for High Definition image resolutions such as 480p, 480i, 720p, 1080i & 1080p.

- Full HDMI & HDCP Compatible
- HDMI to Mini HDMI Cable
- Length: 2m

HLV1130 27331130 2M MINI HDMI TO HDMI A LEAD

18GBPS HDMI LEADS

GOLD
PLATED CONNECTORS

4K18
ULTRAHD GBPS

3D

Deep Colour
x.v.Colour

HDMI
HIGH SPEED

NEW



- UHD 4K 2160p@60Hz
- 48-Bit Deep Colour
- HDR + ARC

	0.5m	HL18G0.5M	27478005	BI-DIRECTIONAL
	1m	HL18G1M	27478010	BI-DIRECTIONAL
	2m	HL18G2M	27478015	BI-DIRECTIONAL
	3m	HL18G3M	27478020	BI-DIRECTIONAL
	5m	HL18G5M	27478025	BI-DIRECTIONAL
	7.5m	HL18G7.5M	27478030	BI-DIRECTIONAL
	10m	HL18GA10M	27478040	DIRECTIONAL (INTEGRATED CHIPSET)
	15m	HL18GA15M	27478050	DIRECTIONAL (INTEGRATED CHIPSET)

HDMI LEADS

18GBPS FIBRE HDMI 2.0 ACTIVE OPTICAL CABLE



HDMI 2.0 Active Optical Cable (AOC) is used to extend the transmission distance between HDMI source and sink devices. The transmission distance can be up to 200m (660ft) through a hybrid cable consisting of optical fibers and copper wires. The high-speed TMDS signals are transmitted through the Optical multimode fibers, while the low frequency control signals are transmitted through the copper wires.

To support the new HDMI 2.0 specification, HDMI 2.0 AOC is now compliant with Blu-ray players and TV sets supporting 4K display resolutions.

With advanced optical engine embedded, it is feasible to connect any HDMI devices such as Blu-ray, DVD, projectors, video games, computers and mobile to enjoy the high quality display.

- Suitable for digital home theatre, conference room, auditorium, LED signboards, outdoor advertising, panel information displays for airports and stadiums, etc.
- Compliant to link with all HDMI A-type connector
- Compliant with HDMI 1.4b and 2.0 specification
- Longer, thinner cable without EMI/RFI emissions
- Proven 850 nm VCSEL array technology
- Low power consumption

20M	HL18GF20M	27476070	100M	HL18GF100M	27476110
30M	HL18GF30M	27476080	150M	HL18GF150M	27476120
50M	HL18GF50M	27476090	200M	HL18GF200M	27476130
70M	HL18GF70M	27476100			

TELEPHONE

TELEPHONE LEADS

RJ12 modular telephone line cord. Extend your telephone with this modular extension lead.

- Flat telephone cable fitted on both ends with RJ12 modular telephone plugs
- Modular plug to Modular plug
- 4 Conductor (6P4C)



			COLOUR	
	2M	LC0051/BLK	43075150	● TELEPHONE RJ12 TO RJ12 LEAD
	3M	LC0056B/BLK	43075155	●
	5M	LC0091B/BLK	43075160	●
	10M	LC0095B/BLK	43075165	●
	2M	LC0051B/IVY	43075052	●
	3M	LC0056/IVY	43075054	●
	5M	LC0092/IVY	43075055	●
	10M	LC0076B/IVY	43075056	●

NANO + MICRO SIM CARD ADAPTOR



- 1x Nano to Micro SIM adaptor
- 1x Micro to Standard SIM adaptor
- 1x Nano to Standard SIM adaptor

NANOSIM1 43070240

TELEPHONE EXTENSION



- RJ12 connectors
- 15 metre length
- Constructed from durable plastic

ERM4015B/WHT 43075060

PREMIUM COMPONENT LEADS

GOLD
PLATED CONNECTORS



- 3x RCA Gold Plated Plugs to Plugs
- Component Video RGB (Red/Green/Blue) Interconnects
- Crystal Clear Transparent Jacket
- SPC Braid, Double Shielding

1.5M	HLV0909	27330909
5M	HLV0915	27330915

VGA TO YPBPR LEADS



- VGA to Component lead
- Featuring a high density 15-Pin plug to 3 x Component RCA
- Designed to be used from DVD to projector with switchable RGB or component video input



2M	LV5182	27475182	VGA TO COMPONENT VIDEO
5M	LV5184	27475184	VGA PLUG TO COMPONENT

COMPONENT VIDEO LEADS

GOLD
PLATED CONNECTORS



- 3x RCA Plugs to 3x RCA Plugs (Green, Blue & Red)
- Gold Plated Connectors
- 75Ω shielded lead

0.3M	LV5186	27475186
1M	LV5188	27475188
2M	LV5190	27475190
3M	LV5192	27475192
5M	LV5194	27475194
10M	LV5196	27475196
15M	LV5198	27475198
20M	LV5200	27475200

MONO RCA LEADS

GOLD
PLATED CONNECTORS



Heavy duty RG59 Coaxial cable to moulded gold plated RCA plugs. High Performance for greater detail and definition.

2M	LV5163	27475163
3M	LV5166	27475166
5M	LV5167	27475167
10M	LV5168	27475168

PLUG TO PLUG LEAD



0.3M	LV1495	27471495	▪ 75Ω
2M	LV1501	27471501	▪ Coaxial lead

2M VGA PLUG TO 5 BNC PLUG LEAD

- Colour coding for easy identification
- Fully braided and shielded
- Ferrite cores on each end for noise suppression



LV1560	27471560
---------------	----------

2M BNC PLUG TO RCA PLUG

- 75Ω
- Coaxial shielded cable

2M	LV1008	27471008
----	---------------	----------



PREMIUM S-VIDEO LEAD

GOLD
PLATED CONNECTORS



- 1x 4-Pin S-VIDEO Plug to Plug
- Crystal Clear Transparent Jacket
- SPC Braid, Double Shielding

1.5M	HLV0930	27330930
------	----------------	----------

S-VIDEO LEAD

GOLD
PLATED CONNECTORS



- High quality 4-Pin Mini DIN Plug to 4-Pin Mini DIN Plug

2M	LV0780	27470780
10M	LV0787	27470787

1.5M S-VIDEO & AUDIO LEAD

GOLD
PLATED CONNECTORS

- Oxygen-Free Cable
- Combination AV Lead with Twin Gold Plated RCA Audio Plugs
- Rubberized Flexible Lead 6mm Ø x 14mm

LH0775	27470775
---------------	----------





COMPONENTS

56-58 PLUGS, SOCKETS & ADAPTORS

59-69 WALL PLATES

DVI SOCKET TO SOCKET



- Joiner/ Gender changer bender
- Digital video interface adaptor
- Compatible with DVI-I Single/ Dual Link, DVI-D Single/ Dual Link and DVI-A male
- All pins wired straight through

PA4250 30254250

VGA SOCKET TO DVI-I PLUG



- Ideal for connection PCs with VGA output to a PC monitor with a DVI input
- DVI: 24 + 5 pins
- VGA: 15 pins

PA4245 30254245

TOSLINK RIGHT ANGLE ADAPTOR



- 90 degrees right angle adaptor
- Plug end can be rotated 360 degrees for easy installation

PA1908 30251908



HDMI SOCKET TO DVI-D PLUG



- Convert your HDMI input to a DVI-D output
- High quality casing

PA4270 30254270

DVI-D SOCKET TO HDMI PLUG



- Convert your HDMI input to a DVI-D output and vice versa
- High quality casing

PA4275 30254275

HDMI JOINER



- Extend the length of your HDMI leads
- HDMI socket to HDMI socket

PA4280 30254280

HDMI RIGHT ANGLE ADAPTOR

GOLD
PLATED CONNECTORS

- HDMI plug (19-Pin type A) to HDMI socket jack (19-Pin type A)
- Right angle horizontal flat top
- Perfect for Wall Mounted TV's and other tight spaces
- Compatible with HDMI Version 2.0



PA4295 30254295

MICRO HDMI PLUG TO HDMI SOCKET

GOLD
PLATED CONNECTORS



PA4365 30254365

180 DEGREE HDMI SWIVEL ADAPTOR

GOLD
PLATED CONNECTORS

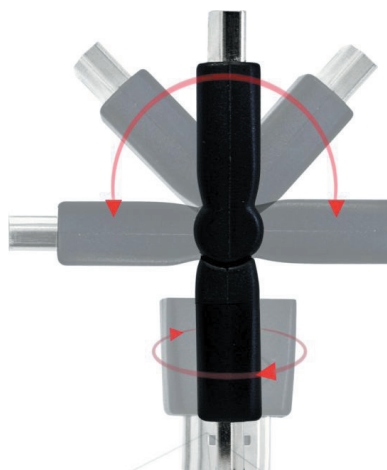

If you are having trouble making an easy and accessible HDMI connection to your AV components, this adaptor might be the solution for you.

- 180° swivel and rotation
- Can be used with any HDMI cable HDMI plug to HDMI socket

PA4300 30254300

DISPLAYPORT TO HDMI ADAPTOR

GOLD
PLATED CONNECTORS



- DisplayPort 20-Pin plug to HDMI 19-Pin socket

PA4350 30254350

DISPLAYPORT TO DVI ADAPTOR

GOLD
PLATED CONNECTORS



- DisplayPort 20-Pin male to DVI-I 29-Pin female

PA4355 30254355

DISPLAYPORT TO VGA ADAPTOR

GOLD
PLATED CONNECTORS



- DisplayPort 20-Pin plug to VGA HDB 15-Pin socket

PA4360 30254360

MINI HDMI PLUG TO HDMI SOCKET

GOLD
PLATED CONNECTORS



PA4370 30254370

DUAL-SIDED USB 2.0 RIGHT-ANGLE ADAPTOR



- Connector 1: USB 2.0 Type A Socket
- Connector 2: USB 2.0 Type A Reversible Plug

PA2311 30252311

USB A PLUG TO MICRO USB B PLUG



Great for connecting and charging small devices directly from laptop USB ports.

PA2346 30252346

RJ45 CROSSOVER ADAPTOR

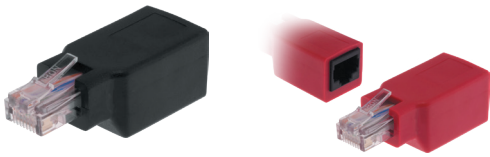

Use this adaptor to connect two computers directly via Ethernet when only a patch lead is available.

PK4040 30634040 CAT5E

PK4045 30634045 CAT6

PS/2 ADAPTORS



Allows you to connect your PS2 keyboard or mouse to your computer's USB Port.

PA2300 30252300 PS2 SOCKET TO USB-A PLUG

PA2305 30252305 PS2 PLUG TO USB-A SOCKET

USB JOINER/GENDER CHANGER



PA2310 30252310 USB-A SOCKET TO USB-A SOCKET

PA2313 30252313 USB-A SOCKET TO USB-B PLUG

PA2316 30252316 USB-A PLUG TO USB-A PLUG

PA2319 30252319 USB-A PLUG TO USB-B SOCKET

PA2322 30252322 USB-B SOCKET TO USB-B SOCKET

PA2325 30252325 USB-A SOCKET TO USB-B SOCKET

USB3.0 JOINER/GENDER CHANGER



PA2328 30252328 USB-A SOCKET TO USB-A SOCKET

PA2334 30252334 USB-A PLUG TO USB-A PLUG

PA2337 30252337 USB-A PLUG TO USB-B SOCKET

PA2340 30252340 USB-B SOCKET TO USB-B SOCKET

PA2343 30252343 USB-A SOCKET TO USB-B SOCKET

PHONO (2.5/3.5/6.3MM)

6 WAY 3.5MM HEADPHONE HUB

- Connect up to 5 head phones with your iPod or any other portable media device
- 3.5mm stereo sockets, compatible with any iPod, iPhone, MP3 player, DVD player etc.



PA1063 30251063

TTRS TO STEREO & MIC ADAPTOR

- Works with most of TTRS devices
- High Quality Silver Plated Connectors
- Great for PC gaming headsets



PA1080BL	30251080	BLACK
PA1078WH	30251078	WHITE

RCA PLUG PRESS TERMINATION



- Saves time and the trouble of soldering your connections
- Use the press terminals to have a firm and reliable connection in seconds!
- Sold individually - single plug only

PD2920 30362920

RCA GROUND LOOP ISOLATOR

RCA



The PRO1059 will solve the problem of ground loop issues and easily connects in any audio system!

- Frequency range: 10~20,000Hz
- Insertion loss: 1dB @ 1kHz
- Connection: RCA Sockets to RCA Plugs
- Channel separation: 45dB @ 1kHz minimum

PRO1059 40451285

SCART PLUG TO RCA & S-VIDEO

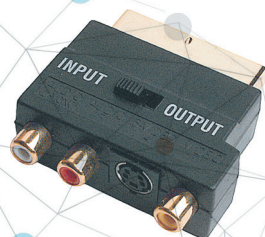

- Input - Output mode switch
- 21 pin SCART to RCA & S-Video
- Designed to allow regular RCA, or S-Video leads to connect to SCART socket and vice versa

PA4220 30254220

RIGHT-ANGLE ADAPTOR

VGA - SCART



PA4305	30254305	Upwards
PA4310	30254310	Downwards

FIBRE OPTIC SC FAST CONNECTOR

FIBRE



- Low insertion loss, high return loss
- Complies IEC61754-4 standard
- Long life span

PR2320 30852320



AV EXTENDER WALL PLATES

COMPOSITE STEREO AUDIO CAT5

- Includes mounting hardware
- Easy D.I.Y. installation
- Colour-coded IDC contacts
- Audio/Colour video: Category 5e UTP cable up to 100 metres

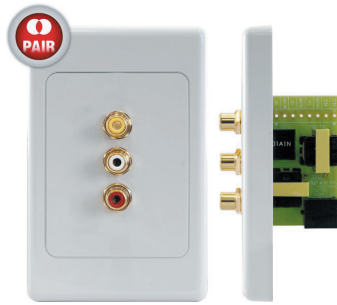

PR01177 39893331

COMPONENT + STEREO OVER CAT5

- Video: 3 RCA(Y/Pb/Pr) sockets; (Green, Blue and Red)
- Audio: 2 RCA stereo left and right(White and Red)
- UTP: RJ45
- Over one CAT5 cable



PR01276WP 07350097

AUDIO VIDEO & COMPONENT + IR

Designed to be surface mounted in in-wall composite/component video, and stereo audio/digital audio with IR control applications.

- Connected by two CAT5 cables



PR01254D 39894091

COMPONENT DIGITAL AUDIO CAT5

- Video: 3 RCA(Y/Pb/Pr) sockets; (Green, Blue and Red)
- Audio: 1 RCA Digital Coaxial
- Over one CAT5 cable



PR01169 39893335

HDMI OVER CAT5E/6 WALL PLATE

- With infrared control signal passing through function
- Compatible with 3D format
- Transmission distance up to 60m with 1080p video format



HDC6WP 39893348

COMPONENT VIDEO CAT5 EXTENDER

This clipsal style wall plate delivers component video using economical CAT5e cable.

- Punch-down

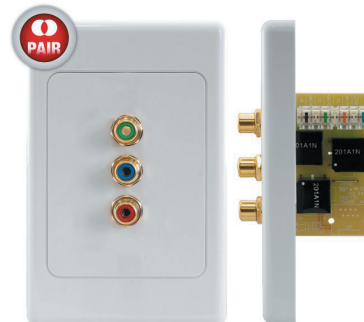

PR01170 39893337

COMPONENT + IR WALL PLATE (PAIR)

Send component signals over long distances using economical CAT5 cable and control your AV devices remotely.



PR01200 39894072

ACTIVE COMPOSITE STEREO + IR (PAIR)





Twisted pair extenders allow long distance distribution of audio and video using inexpensive CAT5e cables.

PR01199 39894067

HDMI WALL PLATES



- Silver plated HDMI certified 1.3a compliant connectors for uncompromising performance
- Available only in HDMI rear cable/dongle version for essential in-wall flexibility
- Easy to install with clip on frame surround to cover mounting points
- Mounting hole spacing compatible for use in USA, Australia & New Zealand

	HDMI1H	39893299	1X HDMI HORIZONTAL
	HDMI1FLEX	39893300	1X HDMI VERTICAL
	HDMI2FLEX	39893303	2X HDMI VERTICAL

USB WALL PLATE

1x USB 2.0 High Speed socket to socket through connection.

- Flexible cable extension on rear
- Vertical mount design
- Designed with Stainless Steel USB mounting screws

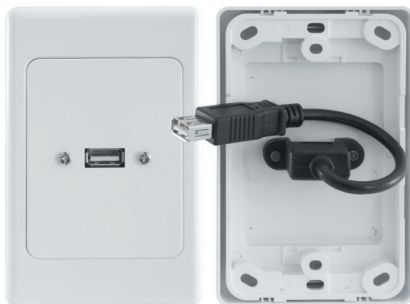

PRO1237 39893390

HDMI + USB VERTICAL WALL PLATE



- This wall plate features a flexible lead on the rear HDMI and USB sockets, allowing easy installation

PK3304 39893304

HDMI VGA USB 3.5MM AUDIO



This wall plate features flexible leads on the rear sockets, allowing easy installation and allows natural fall of cables in-wall, relieving tension on the wall socket.

- HDMI connection rated High Speed with Ethernet
- Compliments Clipsal 2000 plate design

PRO1345 39893400

DUAL HDMI VERTICAL WALL PLATE



- 2x HDMI input
- Modular HDMI female to female socket
- 2x mounting bolts
- 2x short screws

PRO1182 39893317

AV WALL PLATES

COMPOSITE AV WALL PLATE

GOLD
PLATED CONNECTORS



- Clipsal-style composite video + audio (3x RCA) wall plate

PR01121 39893321

COMPONENT VIDEO + STEREO AUDIO

GOLD
PLATED CONNECTORS



- Component Video/Stereo Audio Wall Plate with RCA jacks
- Mounting hardware supplied: 2x mounting bolts, 2x short screws

PR01117 39893325

HDMI COMPONENT STEREO DIGITAL

GOLD
PLATED CONNECTORS



- Green/blue/red - Component video
- Amber - Digital audio
- White/Red - Stereo audio

PR01258A 39893343

VGA + COMPOSITE AV + PC AUDIO



- 1x VGA socket to socket
- 1x 3.5mm stereo audio socket to socket
- 3x Video/Stereo audio RCAs, socket to socket (Yellow/White/Red)

PR01277 39893350

VGA + USB + STEREO WALL PLATE

- 1x VGA socket to socket
- 1x 3.5mm stereo audio socket to socket
- 3x Video/Stereo audio RCAs, socket to socket (Yellow/White/Red)



PR01279 39893355

VGA S-VIDEO COMPOSITE VIDEO



- 1x VGA socket to socket
- 1x 3.5mm stereo audio socket to socket
- 1x S-video socket to socket
- 1x Video RCA socket to socket (Yellow)

PR01280 39893360

VGA COMPOSITE AV USB PC AUDIO

- 1x VGA Female to Female
- 1x 3.5mm stereo audio socket
- 3x RCA socket to socket (Yellow/White/Red)
- 1x USB socket to socket on flexible lead
- Connect your USB, VGA, 3.5mm Audio and RCA cables from your desired source to wall



PR01309 39893370

HDMI VGA COMPOSITE AV PC

- 1x HDMI socket on flexible lead
- 1x VGA Female to Female
- 1x 3.5mm stereo audio socket
- 3x RCA socket to socket (Yellow/White/Red)
- Connect your HDMI, VGA, 3.5mm Audio and RCA cables from your desired source to wall



PR01310 39893375

HDMI VGA WALL PLATE

This wall plate features a flexible lead on the rear HDMI socket, allowing easy installation and allows natural fall of cables in-wall, relieving tension on the wall socket.

PR03420 39893420



USB VGA PC AUDIO WALL PLATE



- Connect your VGA, 3.5mm Audio and VGA cables from your desired source to wall

PR01314 39893385

USB-B 3.5MM AUDIO VGA HDMI WALLPLATE



- Flexible lead on rear

PR03425 39893425

RIGHT ANGLE VGA & 3.5MM

- VGA socket to rear right angle connector for use with premade VGA cables
- 3.5mm stereo audio socket to rear right angle socket connector
- Right angle rear connections make it easy to run behind tight walls



PK3309 39893309

STRAIGHT VGA & 3.5MM STEREO

- VGA socket to socket connector for use with premade VGA cables
- No cable termination required









PK3307 39893307



SPEAKER TERMINALS

SPEAKER WALL PLATES



	PRO1030	39893110	2-Way	CLIPSAL-STYLE SPEAKER TERMINAL WALL PLATE
	PRO1032	39893115	4-Way	
	PRO1034	39893117	6-Way	
	PRO1044	39893120	8-Way	
	PRO1143	39893123	12-Way	
	PRO1144	39893122	16-Way	DECORA-STYLE SPEAKER TERMINAL WALL PLATE
	PRO1144A	39893124	14-Way + 1x RCA	

3.5MM AUDIO MODULE



3.5mm stereo socket to socket.

- Socket diameter: 2.8mm
- Lead length: 200mm
- Hexagonal nut

MWI13A35 30634840

1X SPEAKER MODULE

GOLD
PLATED CONNECTORS



- 2x banana sockets to 2x banana sockets for speakers
- With Blank/ Red Rings
- Panel made with ABS material

MWI13SPK 30634845

KEYSTONE MODULE



- Keystone Base modular insert Plate (No fittings)
- ABS plastic material panel

MWI13KS 30634848

VGA MODULE



- VGA socket to socket

MWI13VGA 30634860

HDMI MODULE

GOLD
PLATED CONNECTORS



- Black PVC Jacket
- Flexible lead on the rear HDMI socket
- Relieves tension on the wall socket

MWI13HDMI 30634870

BNC MODULE



- BNC socket to socket
- Easy to install
- Nickel plated

MWI13BNC 30634880

USB 3.0 MODULE



USB 3.0 A type socket to USB 3.0 A type socket module insert.

- Nickel plated connectors
- 20cm flexible extension lead

MWI13USB3 30634867

USB B TYPE MODULE



- USB-B socket to socket

MWI13USBB 30634869

WHITE REVERSE BULLNOSE WALL

This unique wallplate allows cables to enter the wall cavity space without the need for interconnect wallplates in between. Ideal for instances where you have pre-made leads directly out of the wall cavity.

- Low profile design
- Bristle brush design prevents dust and bugs from entering from the wall cavity



BNWP01 11953405

BRUSH WALL PLATES



- Allows cables to enter the wall cavity space without the need for inter-connect wall plates
- Ideal for pre-made leads directly out of the wall cavity
- Brush keeps dust away

	PRO1272	39893365	○	WHITE BRUSH WALL PLATE*
	PRO1272B	39893366	●	BLACK BRUSH WALL PLATE
	EC01272	39893900	○	WHITE BRUSH WALL PLATE*

	PRO1272D	39893367		DECORA BRUSH WALL PLATE
	PRO1273	39893410	○	DUAL BRUSH WALL PLATE

* Pro1272 is Taiwanese made ABS plates. EC01272 is Chinese made Polypropylene plates.

WHITE REVERSE BULLNOSE WALL



This unique wallplate allows cables to enter the wall cavity space without the need for interconnect wallplates in between. Ideal for instances where you have pre-made leads directly out of the wall cavity.

- Low profile design
- Bristle brush design prevents dust and bugs from entering from the wall cavity

REVBWP 11953408

LOW PROFILE BULLNOSE



- Low profile design
- Bristle brush design prevents dust and bugs from entering from the wall cavity
- Wall plate depth: 10mm
- Total depth (inc. dome): 30mm
- Dome depth: 20mm

	LPBNWP	11953407	○
	BNWP01B	11953406	●

MODULAR WALL PLATES

MODULAR WALL PLATE FRAME

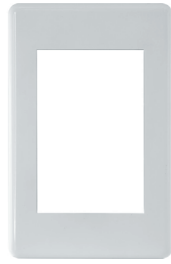

- Build Your Own Custom Wall Plates With Pro.2's MW13 Range

MW13FR 30634800

DUAL 'F' MODULE FOR MW13F

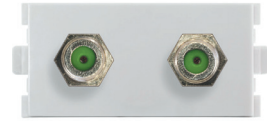

- Metal, 3GHz connector
- ABS material
- Foxtel approved F30583

MW13FF2 30634832

BLANK MODULE FOR MW13FR



- ABS material

MW13BL 30634885

DVI MODULE FOR MW13FR



- 20cm PVC jack lead
- White ABS plate panel

MW13DVI 30634875

USB 2.0 MODULE FOR MW13FR



- USB 2.0 A type socket to USB 2.0 A type socket
- Nickel plated connectors
- 20cm Ø4.5mm black PVC lead

MW13USB2 30634865

PAL MODULE FOR MW13FR



- PAL socket (Front) to F-Type socket (Back)

MW13PF 30634825

F MODULE FOR MW13FR



- 'F' to 'F' socket
- Foxtel approved F30583

MW13FF 30634830

TOSLINK MODULE FOR MW13FR



- Toslink socket to toslink socket module

MW13TOS 30634835

BRUSH MODULE FOR MW13FR



MW13BR 30634890

1X RCA MODULE



- RCA socket to RCA socket
- Yellow colour insulator

MW13RCA1 30634805

2 X RCA MODULE



- 2x RCA socket to 2x RCA socket stereo module

MW13RCA2 30634810

3 X RCA MODULE



- 3x RCA sockets to 3 x RCA sockets AV module

MW13RCA3 30634815

RGB MODULE



- Component RCA sockets to RCA sockets component module

MW13RGB 30634820

CAT5E JOINER MODULE



MW13C5J 30634855

CAT6 JOINER MODULE

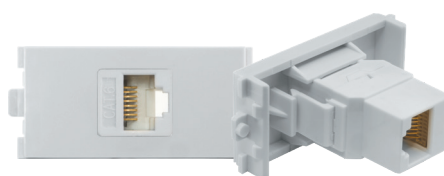

MW13C6J 30634857

CAT6 MECH MODULE

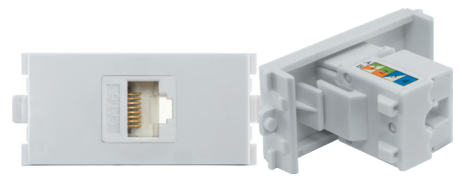

- RJ45 CAT6 mechanism socket

MW13C6M 30634850

BLANK WALL PLATES

XLR BLANK WALL PLATE



- Connecting screws (x2) are included
- Suits narrow flange XLR connectors
- Designed to match Clipsal 2000 wall plates
- Blank wall plate to suit a variety of XLR connectors

PR01240 39893395

GANG ARCHITRAVE PLATE



- Dimensions (HWD): 32x79x11mm
- Ideal for skirting board / architrave mounting or caravan installations

1 GANG PK4576 30634576

2 GANG PK4578 30634578

GANG WALL PLATE

- Dimensions (WHD): 120x73x10mm
- To suit clipsal inserts

PK4580	30634580	1 GANG WALL PLATE
PK4582	30634582	2 GANG WALL PLATE
PK4584	30634584	3 GANG WALL PLATE
PK4586	30634586	4 GANG WALL PLATE
PK4588	30634588	6 GANG WALL PLATE

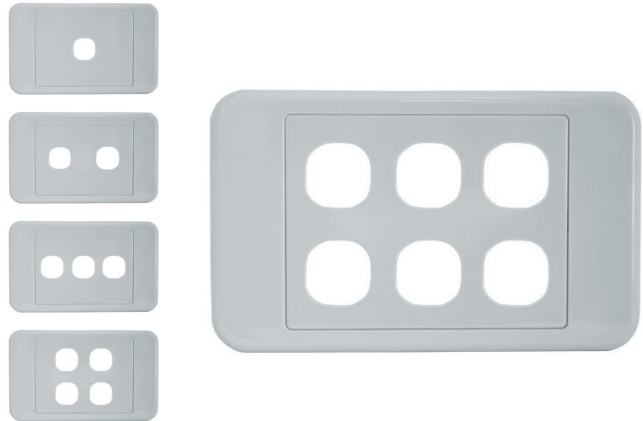

BLANK WALL PLATE WITH CUTOUT



- Decora-style empty insert wall plate
- 2x Short screws included

PR01024 39893327

GANG KEYSTONE WALL PLATE

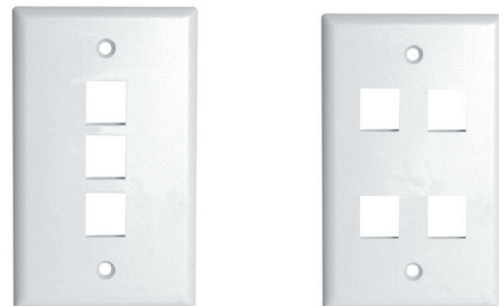

PK4570 30634570 3 GANG

PK4575 30634575 4 GANG WALL PLATE

BLANK WALL PLATE / COVER PLATE



Blank wall plate for use as a cover for previously cut out holes. Suits Clipsal 2000 Series wall plates.

PR01024B 11953401

2 GANG COVER WALL PLATE CUTOUT

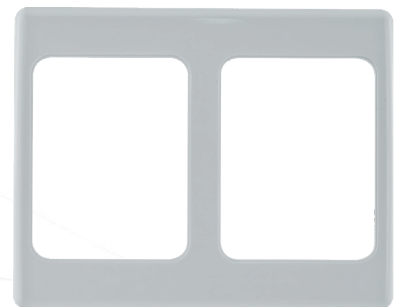

- Cleanly combine 2 wall plates with one bezel for a professional finish
- Clips onto standard Clipsal and Clipsal-style wall plates

PR01153 39893380

TV WALL OUTLETS

PAL TO F SOCKET WALL PLATE

PAL type 75Ω; socket on standard electrical wall plate.

- Front: PAL 75Ω; Socket
- Rear: 'F' Socket

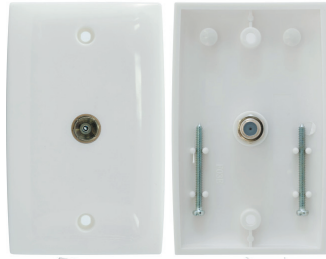

PR3835 30853835

TV WALL PLATE WITH TELEPHONE

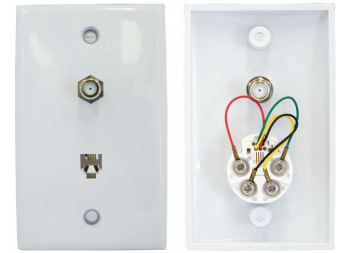

F-Type Socket to Socket - 6P4C telephone connector.



PR3870 30853870

'F' TYPE TV WALL PLATE

GOLD
PLATED CONNECTORS

- | | | | |
|---|---------------|----------|---|
|  | PR3850 | 30853850 | F-TYPE TV WALL PLATE |
|  | PR3860 | 30853860 | TWIN F-TYPE TV WALL PLATE (CLIPSAL-STYLE) |

5V USB KEYSTONE INSERT

- The max output current 3A. Continuous use max 2.1A
- 12V to 5V 1A
- Perfect for Equipment racks, Conference rooms, AV Systems, Planes, Yachts

PK4918 30634918



NEW

HDMI TO HDMI CLIPSAL INSERT

GOLD
PLATED CONNECTORS



HDMI Socket to HDMI Socket (straight-through) modular insert.

PK4702 30634702

PK4704 30634704

- Fits Standard Clipsal and Clipsal-style wall plates
- HDMI Socket to HDMI Socket insert

HDMI TO HDMI RIGHT ANGLE CLIPSAL INSERT

PK4700 30634700

FLEXIBLE USB3.0 INSERT

GOLD
PLATED CONNECTORS



- Approx 10cm lead
- Flat lead for maximum flexibility
- Flexible USB3.0 Insert to suit Clipsal blank modular wall plates
- Ideal for tight spaces in wall cavities, or where cable approach makes it difficult or impossible to connect to socket

PK4694 30634694

FLEXIBLE HDMI TO HDMI INSERT

- Approx 10cm lead
- Flat lead for maximum flexibility

PK4706 30634706



**RCA SOCKET TO
RCA SOCKET**



- Silver plated terminals
- Flush RCA socket
- To suit clipsal wall plate

	PK4662	30634662	•
	PK4664	30634664	•
	PK4666	30634666	•
	PK4668	30634668	•
	PK4670	30634670	○
	PK4672	30634672	•

**'F' SOCKET
KEYSTONE INSERT**

GOLD
PLATED CONNECTORS

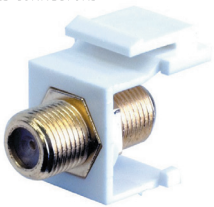

- Features an F socket to socket

PK4601 30634601

**S-VIDEO
KEYSTONE INSERT**



- Features an S-Video socket to IDC terminal

PK4610 30634610

**'F' SOCKET TO 'F'
SOCKET**



- F-Type to F-Type Insert
- Blue terminal
- To suit Clipsal wall plates

PK4640 30634640

**PAL WALL PLATE
INSERTS**



- F-Type socket on rear of insert
- To suit Clipsal wall plates

PK4642 30634642

RCA SOCKET TO 'F' SOCKET

GOLD
PLATED CONNECTORS

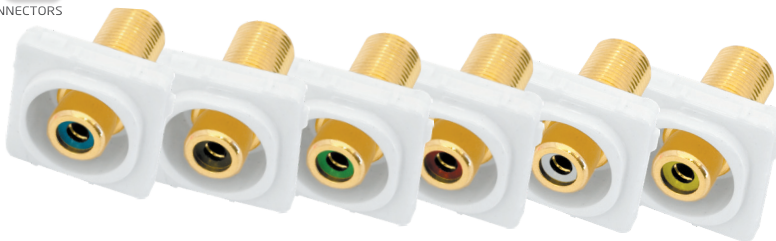

PK4644	30634644	•	PK4650	30634650	•
PK4646	30634646	•	PK4652	30634652	○
PK4648	30634648	•	PK4654	30634654	•

- To suit clipsal wall plate
- Available in 6 different colours

**BLANK INSERT
TO SUIT
CLIPSAL WALL
PLATES**



PK4656 30634656

WALL PLATE INSERTS

GOLD
PLATED CONNECTORS





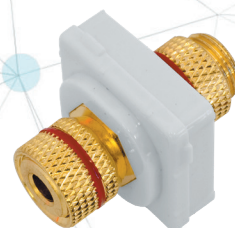

- Speaker terminal for clipsal insert
- Gold plated terminals

	PK4658	30634658	•	BLACK SPEAKER TERMINAL CLIPSAL INSERT
	PK4660	30634660	•	RED SPEAKER TERMINAL CLIPSAL INSERT

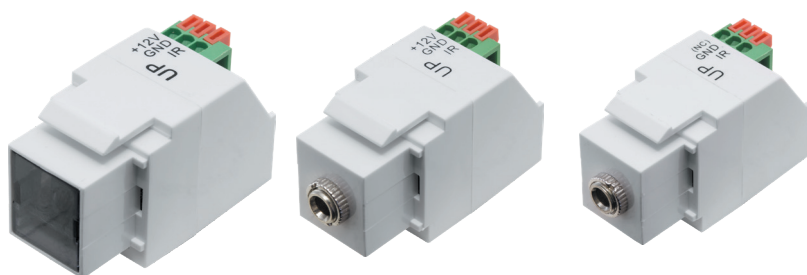

IR KEYSTONE ADAPTER





	PK4912	30634912	DUAL BAND KEYSTONE IR RECEIVER
	PK4914	30634914	IR EMITTER KEYSTONE ADAPTOR
	PK4916	30634916	IR RECEIVER KEYSTONE ADAPTOR

BNC WALL PLATE INSERTS



- Clipsal-style insert

	PK4688	30634688	BNC SOCKET TO BNC SOCKET
	PK4690	30634690	BNC SOCKET TO F-TYPE SOCKET

HDMI KEYSTONE INSERT



Our keystone modules provide a full range of solutions for voice, home networking, home office, audio/video and more. With the wide selection of snap-in modules, you can custom-configure your keystone wall plates and patch panels for greater control and more flexibility.

This HDMI keystone insert enables you to hide your expensive premium HDMI cables behind the wall plate and use normal HDMI cables to connect to your devices. Eliminate the hassle of damaging main HDMI input by frequently plugging and unplugging HDMI cable when you swap devices. Snap-in design makes it easy to install on your keystone wall plate.

Suits perfectly on our MW113KS keystone wall plate module.

- Material of Cover: ABS

PK4910	30634910
---------------	----------



IT SUPPLIES

71-72

SECURITY & INTERCOMS

73

PUBLIC ADDRESS

73

4 PORT USB 2.0 HUB



- USB Version 2.0
- 4 ports, and power up to 500mA each port
- Active or Passive operation—power input for optional external power supply. No need for drivers or software

HUB4 09050715 4 PORT USB 2.0 HUB

USB ETHERNET ADAPTORS



If your PC or Netbook does not have an Ethernet port, but you need the reliability or speed of a wired network connection, then the Pro.2 USB Ethernet adaptors are convenient and compact solutions. Supported by most computers (and operating systems) without installation of special drivers, they are a quick and simple way of joining a LAN to gain internet access, print via network printers, stream media, and access shared files.



UPRS2	43151245	USB 2.0	10M/100M	USB ETHERNET ADAPTOR
UPRS3	43151250	USB 3.0	GIGABIT	

USB MIC AND HEADPHONE ADAPTOR



Eliminate the need for a traditional sound card with PA2295 USB to Mic & Headphone audio adaptor. It's simple to use, simply plug and play!

- USB 2.0 interface
- Speaker/Headphone out jack
- Microphone in jack

PA2295 30252295 USB MIC AND HEADPHONE ADAPTOR

USB CURRENT VOLTAGE METER



- Easily measure the USB port of the output voltage and the device current
- Plug and play, light and easy to carry
- No additional power supply
- Current & voltage display cycle

CVT201 09050725 USB CURRENT VOLTAGE METER

85 IN 1 USB CARD READER

STORAGE MEDIA / CARD READERS



High Speed USB 85-in-1 Multi-Card Reader with SDHC support. With its small form factor, the CR85 is the ideal choice for your data transfer needs, supporting all current card types on the market.

- Formats: CF I to CF IV, SDHC2.0, MiniSD, MicroSD (Transflash), MMC, XD, MS Duo Pro
- USB 2.0 High Speed Interface
- Plug and Play
- Includes mini USB-A to mini-B lead
- Windows, Mac, Linux compatible

CR85 09050630 85 IN 1 USB CARD READER

USB OVER CAT5 EXTENDER

PERIPHERALS / COMPUTER SWITCH BOXES & KVMs



Extends USB 2.0 signal using one CAT5e/6 Cable.

- Connects USB devices to one computer
- Built-in LINK indicators on receiver units
- Built-in 4 ports Hubs on receiver unit

PRO1354 09051710 USB OVER CAT5 EXTENDER

CLEANING & PROTECTIVE KIT

STORAGE MEDIA / AV CASSETTES / AV CLEANERS



General cleaning and protective kit for camcorders, mobile phones, notebooks and more. Includes:

- Brush
- Cleaning fluid
- Cleaning cloth
- Squeegee card
- Foam swabs
- Protective films
- Sandpaper stick

CPK1 42735511 CLEANING & PROTECTIVE KIT

LAPTOP SECURITY LOCK

ACCESSORIES



This lap-lock consists of a simple lock and a metal cable which connect to the inbuilt security slot to a desk leg or secure.

- Length of metal cable: 1.8m
- 4 figure – 10,000 combination codes

LAPLOK01 09009642 LAPTOP SECURITY LOCK

COAXIAL SURGE PROTECTOR

CCTV CAMERAS / ACCESSORIES



The SPF RF / Coaxial protector features robust gas tube technology and provides surge protection for radio frequency and coaxial cables.

- Gas tube: 90V type
- Insertion loss: 0.5dB Max. (50~470 MHz)
- Surge protection attacks time: 100ns
- Maximum surge current: 5000A per 8/20 μ s

SPF 43151080 COAXIAL SURGE PROTECTOR

PUBLIC ADDRESS

3 CHANNEL MICROPHONE MIXER

AUDIO MIXERS



Passive 3 Microphone mixer with Aux input.

- Including 3 unbalanced mono jack and 2 RCA connectors
- Each channel is adjustable
- Easy to install

PRO1348 01454790 3 CHANNEL MICROPHONE MIXER

STEREO AUDIO POWER AMPLIFIER

PA AMPLIFIERS



Provides manual or remote volume control.

- Amplifier Type: Stereo Class-D
- Provides volume level indicator
- Provides 3 IR path remote control
- Stereo RCA inputs
- Output power: 15W (rms) per channel (@ $RL=4\Omega$)

PRO1358 01454132 STEREO AUDIO POWER AMPLIFIER

MODEL NUMBER INDEX

8P2HDMI	42	FP7759	36	HLVF1	48	LC1230	43	LC6684Y	35	LC7532BL	35	PA4275	56	PRO1191	28
ADM5	14	FP7770	36	HLVF2	48	LC1250	43	LC6687Y	35	LC7534BL	35	PA4280	56	PRO1199	59
AV212	6	H2SPC5L	19	HLVF3	48	LC1255	43	LC6690Y	35	LC7536BL	35	PA4295	56	PRO1200	59
AV2HDMI	5	H4SPC5L	19	HLVF5	48	LC1260	43	LC6693Y	35	LC7538BL	35	PA4300	56	PRO1211	9
AV313	6	H8SPC5L	19	HLVR10	48	LC1270	43	LC6696Y	35	LC7805	40	PA4305	58	PRO1221	9
BMR3X	23	HA01	13	HLVR15	48	LC1280	43	LC6699Y	35	LC7807	40	PA4310	58	PRO1235D	16
BNWP01	64	HC01	4	HLVR20	48	LC1290	43	LC6702Y	35	LC7815	40	PA4350	56	PRO1235DS	16
BNWP01B	64	HD02ECO	4	HLVR30	48	LC1300	43	LC6735W	35	LC7825	40	PA4355	56	PRO1235DSWP	16
CPK1	72	HD41QMV	7	HLVR40	48	LC1310	43	LC6735W	35	LC7855	40	PA4360	56	PRO1237	60
CR85	72	HD4DCAD	6	HR04	13	LC1370	43	LC6738W	35	LC7865	40	PA4365	56	PRO1240	66
CVT201	71	HDC6ECO	10	HUB4	71	LC1380	43	LC6738W	35	LH0328	31	PA4370	56	PRO1247D	16
DAC212	5	HDC6L	10	HV02	45	LC1400	43	LC6741W	35	LH0775	53	PD2920	58	PRO1247DS	16
DAD51	5	HDC6WP	59	HVY02	4	LC1400	43	LC6744W	35	LPBNWP	64	PK3304	60	PRO1247DSWP	16
EC01272	64	HDCP2214V2	5	IPDAU	42	LC1410	43	LC6747W	35	LV0780	53	PK3307	62	PRO1254D	59
EL59Q-0.3PP	47	HDMI16SPEDID	18	IPLC1GD	42	LC1500	44	LC6750W	35	LV0787	53	PK3309	62	PRO1255	27
EL59Q-1.5PP	47	HDMI1FLEX	60	IPLC1GRAY	42	LC1510	44	LC6753W	35	LV1002	33	PK4040	57	PRO1256	25
EL59Q-10PP	47	HDMI1H	60	IPLC1SLV	42	LC1530	44	LC6756W	35	LV1004	33	PK4045	57	PRO1257	28
EL59Q-1PP	47	HDMI2FLEX	60	IRE12	25	LC1540	44	LC6915	34	LV1005	33	PK4570	66	PRO1258A	61
EL59Q-2PP	47	HDMI2SP	18	IRE12SPT	25	LC1550	44	LC7100B	34	LV1006	33	PK4575	66	PRO1259	5
EL59Q-3PP	47	HDMI2SPV2	18	ISHUFFLE2USB	42	LC2010	43	LC7102B	34	LV1008	53	PK4576	66	PRO1262	5
EL59Q-5PP	47	HDMI3S4K	7	LA0469	33	LC2012	43	LC7104B	34	LV1110	33	PK4578	66	PRO1270	17
ELHD005	49	HDMI3SM	6	LA0470	33	LC2025	43	LC7106B	34	LV1115	33	PK4580	66	PRO1270S	17
ELHD010	49	HDMI4AVR	7	LA0471	33	LC5081	46	LC7112B	34	LV1117	33	PK4582	66	PRO1272	64
ELHD020	49	HDMI4S18G	7	LA0473	33	LC5085	46	LC7114B	34	LV1120	33	PK4584	66	PRO1272B	64
ELHD030	49	HDMI4SP	18	LA0474	33	LC5086	46	LC7118B	34	LV1495	53	PK4586	66	PRO1272D	64
ELHDS005	49	HDMI4SPV2	18	LA0477	33	LC5090	46	LC7122B	34	LV1501	53	PK4588	66	PRO1273	64
ELHH005	49	HDMI5SM	6	LA0478	33	LC5093	46	LC7125B	34	LV1560	53	PK4601	68	PRO1276	9
ELHH010	49	HDMI8SPEDID	18	LA0480	33	LC6037	46	LC7127B	34	LV5124	46	PK4610	68	PRO1276WP	59
ELHH015	49	HDMI8SPV2	18	LA1030	31	LC6090	44	LC7138G	34	LV5163	52	PK4640	68	PRO1277	61
ELHH030	49	HDMI1AW	12	LA1031	31	LC6092	44	LC7139G	34	LV5166	52	PK4642	68	PRO1279	61
ELHH050	49	HDMI1AWRX	12	LA1033	31	LC6094	44	LC7140G	34	LV5167	52	PK4644	68	PRO1280	61
ELHH075	49	HDMIFIB18G	12	LA1035	31	LC6096	44	LC7141G	34	LV5168	52	PK4646	68	PRO1287	5
ELHH100	49	HDMIFIB4K	12	LA1039	31	LC6098	44	LC7142G	34	LV5182	52	PK4648	68	PRO1292	24
ELHHS005	49	HDMIPECOV2	11	LA1042	31	LC6150	41	LC7143G	34	LV5184	52	PK4650	68	PRO1294B	25
ELHHS010	49	HDMIPECOV2RX	11	LA1044	31	LC6152	41	LC7144G	34	LV5186	52	PK4652	68	PRO1296	15
ELHHS020	49	HDMIIPRO	11	LA1045	31	LC6153	41	LC7145G	34	LV5188	52	PK4654	68	PRO1297	26
ELHHS030	49	HDMIIPPRORX	11	LA1048	32	LC6160	41	LC7148Y	34	LV5190	52	PK4656	68	PRO1298	5
ERM4015B/WHT	51	HDMIKVMV2	10	LA1050	32	LC6162	41	LC7149Y	34	LV5192	52	PK4658	68	PRO1299	21
FIB100M	37	HDMIMX42V2	8	LA1051	32	LC6163	41	LC7150Y	34	LV5194	52	PK4660	68	PRO1300	21
FIB100MLC	37	HDMIMX4422	8	LA1052	32	LC6170	41	LC7151Y	34	LV5196	52	PK4662	68	PRO1309	61
FIB100OD	37	HDMIMX88V2	8	LA1053	32	LC6172	41	LC7152Y	34	LV5198	52	PK4664	68	PRO1310	61
FIB100ODLC	37	HDVC01	17	LA1055	32	LC6190	41	LC7153Y	34	LV5200	52	PK4666	68	PRO1314	62
FIB100SF	37	HDVC100	13	LA1057	32	LC6210	42	LC7154Y	34	MW13FR	65	PK4668	68	PRO1323	22
FIB150M	37	HE01	17	LA1059	32	LC6216	42	LC7155Y	34	MW13A35	63	PK4670	68	PRO1326	24
FIB150MLC	37	HL18G0.5M	50	LA1061	32	LC6218	42	LC7160OR	34	MW13B1L	65	PK4672	68	PRO1327	20
FIB200M	37	HL18G1M	50	LA1063	31	LC6220	42	LC7185	39	MW13BNC	63	PK4688	69	PRO1328	22
FIB250M	37	HL18G2M	50	LA1065	31	LC6225	42	LC7186	39	MW13BR	65	PK4690	69	PRO1328K	22
FIB300M	37	HL18G3M	50	LA1067	31	LC6500B	34	LC7188	39	MW13C5J	65	PK4694	67	PRO1328WP	22
FL59Q-0.3FF	47	HL18G5M	50	LA1077	33	LC6502B	34	LC7189	39	MW13C6J	65	PK4700	67	PRO1330	24
FL59Q-0.5CFF	47	HL18G7.5M	50	LA1081	31	LC6504B	34	LC7190	38	MW13C6M	65	PK4702	67	PRO1338	15
FL59Q-0.5PF	47	HL18GA10M	50	LA1092	31	LC6506B	34	LC7195	39	MW13DVI	65	PK4704	67	PRO1340	20
FL59Q-0.5PP	47	HL18GA15M	50	LA3013	32	LC6508B	34	LC7200	39	MW13FF	65	PK4706	67	PRO1343	20
FL59Q-0.5PPW	47	HL18GF100M	51	LA3015	32	LC6512B	34	LC7203	39	MW13FF2	65	PK4910	69	PRO1345	60
FL59Q-1.5PF	47	HL18GF150M	51	LA3017	32	LC6514B	34	LC7210	39	MW13HDMI	63	PK4912	69	PRO1348	73
FL59Q-1.5PP	47	HL18GF200M	51	LA3020	32	LC6516B	34	LC7215	38	MW13KS	63	PK4914	69	PRO1351	23
FL59Q-10PP	47	HL18GF20M	51	LA3033	32	LC6600B	35	LC7218	38	MW13PF	65	PK4916	69	PRO1351WP	23
FL59Q-1CFF	47	HL18GF30M	51	LA3035	32	LC6603B	35	LC7222	35	MW13RCA1	65	PK4918	67	PRO1354	72
FL59Q-1PF	47	HL18GF50M	51	LA3037	32	LC6603B	35	LC7224	38	MW13RCA2	65	PNC616	5	PRO1358	73
FL59Q-1PP	47	HL18GF70M	51	LA3038	32	LC6606B	35	LC7225	38	MW13RCA3	65	PR2320	58	PRO1359	15
FL59Q-1PPW	47	HLA8050	31	LA3041	32	LC6606B	35	LC7227	35	MW13RGB	65	PR3850	67	PRO1362D	9
FL59Q-2CFF	47	HLA8070	33	LA3049	32	LC6609B	35	LC7230W	34	MW13SPK	63	PR3860	67	PRO1363	9
FL59Q-2PF	47	HLA8073	33	LA3061	33	LC6612B	35	LC7231W	34	MW13TOS	65	PR3870	67	PRO1363A	9
FL59Q-2PP	47	HLA8076	33	LA3063	33	LC6615B	35	LC7232W	34	MW13USB2	65	PRO1001	29	PRO1369	25
FL59Q-2PPW	47	HLA8080	31	LA3082	32	LC6618B	35	LC7233W	34	MW13USB3	63	PRO1022	28	PRO1369SPT	25
FL59Q-3PP	47	HLDS0.5M	48	LA3097	32	LC6621B	35	LC7234W	34	MW13USBB	63	PRO1024	66	PRO1376	7
FL59Q-3PPW	47	HLDS0.5W	48	LA3098	32	LC6623B	35	LC7235W	34	MW13VGA	63	PRO1024B	66	PRO1387	20
FL59Q-5PP	47	HLDS1W	48	LA8000	33	LC6625B	35	LC7236W	34	NANOSIM1	51	PRO1030	63	PRO1398	23
FL6Q-1.5PF	47	HLDS2W	48	LA8012	33	LC6628R	35	LC7237W	34	PA005	20	PRO1032	63	PRO3420	62
FL6Q-1.5PP	47	HLDS3W	48	LAPLOK01	72	LC6628R	35	LC7241	39	PA1063	58	PRO1034	63	PRO3425	62
FL6Q-1.5PPW	47	HLV0909	52	LC0051/BLK	51	LC6630R	35	LC7243	39	PA1078WH	58	PRO1044	63	R3835	67
FL6Q-10CFF	47	HLV0915	52	LC0051B/IVY	51	LC6630R	35	LC7245	40	PA1080BL	58	PRO1047	15	REVBWP	64
FL6Q-15CFF	47	HLV0930	53	LC0056/IVY	51	LC6633R	35	LC7251	39	PA1908	55	PRO1048	6	RFMX3	14
FL6Q-3CFF	47	HLV0969	45	LC0056B/BLK	51	LC6633R	35	LC7256	39	PA2295	71	PRO1059	58	RFMX3IR	14
FL6Q-3PF	47	HLV0970	45	LC0076B/IVY	51	LC6636R	35	LC7261	39	PA2300	57	PRO1075	28	RFMX3IRST	14
FL6Q-5CFF	47	HLV0973	45	LC0091B/BLK	51	LC6639R	35	LC7266	39	PA2305	57	PRO1117	61	SATA45	46
FP7600	37	HLV0975	45	LC0092/IVY	51	LC6642R	35	LC7500BK	35	PA2310	57	PRO1121	61	SC4K2K	4
FP7602	37	HLV0976	45	LC0095B/BLK	51	LC6645R	35	LC7500BK	35	PA2311	57	PRO1141	24	SPC5RX	19
FP7604	37	HLV0979	45	LC1000	43	LC6648R	35	LC7502BK	35	PA2313	57	PRO1142	24	SPF	73
FP7606	37	HLV0980	45	LC1010	43	LC6654G	35	LC7502BK	35	PA2316	57	PRO1143	63	SPS2A	29
FP7608	37	HLV0981	45	LC1050	43	LC6654G	35	LC7504BK	35	PA2319	57	PRO1144	63	SPS4	29
FP7618	36	HLV0983	45	LC1060	43	LC6657G	35	LC7504BK	35	PA2322	57	PRO1144A	63	SPS6	29
FP7620	36	HLV0986	45	LC1070	43	LC6657G	35	LC7506BK	35	PA2325	57	PRO1153	66	UPRS2	71
FP7622	36	HLV0987	45	LC1080	43	LC6660G	35	LC7508BK	35	PA2328	57	PRO1161	28	UPRS3	71
FP7624	36	HLV0989	45	LC1100	43	LC6660G	35	LC7510BK	35	PA2334	57	PRO1163P	28	USB-DB25	40
FP7640	36	HLV0991	45	LC1110	43	LC6663G	35	LC7512BK	35	PA2337	57	PRO1169	59	USB-RS232	40
FP7642	36	HLV0993	45	LC1120	43	LC6666G	35	LC7514BK	35	PA2340	57	PRO1170			

00760650	15	27311045	31	27471560	53	27725086	46	27727114	34	27727750	36	30634800	65	39893900	64
00760652	15	27311048	32	27475124	46	27725090	46	27727118	34	27727751	36	30634805	65	39894038	28
00760656	15	27311050	32	27475163	52	27725093	46	27727122	34	27727753	36	30634810	65	39894060	28
00771070	47	27311051	32	27475166	52	27726037	46	27727125	34	27727755	36	30634815	65	39894062	28
00771080	47	27311052	32	27475167	52	27726090	44	27727127	34	27727757	36	30634820	65	39894063	28
00771090	47	27311053	32	27475168	52	27726092	44	27727138	34	27727759	36	30634825	65	39894067	59
00771100	47	27311055	32	27475182	52	27726094	44	27727139	34	27727770	36	30634830	65	39894072	59
00771110	47	27311057	32	27475184	52	27726096	44	27727140	34	27727805	40	30634832	65	39894085	16
00771120	47	27311059	32	27475186	52	27726098	44	27727141	34	27727807	40	30634835	65	39894086	16
00771130	47	27311061	32	27475188	52	27726150	41	27727142	34	27727815	40	30634840	63	39894087	16
00771140	47	27311063	31	27475190	52	27726152	41	27727143	34	27727825	40	30634845	63	39894088	16
00771150	47	27311065	31	27475192	52	27726153	41	27727144	34	27727855	40	30634848	63	39894089	16
00771160	47	27311067	31	27475194	52	27726160	41	27727145	34	27727865	40	30634850	65	39894090	16
00771170	47	27311077	33	27475196	52	27726162	41	27727148	34	30251063	58	30634855	65	39894091	59
00771200	47	27311081	31	27475198	52	27726163	41	27727149	34	30251078	58	30634857	65	39894094	17
00771210	47	27311092	31	27475200	52	27726170	41	27727150	34	30251080	58	30634860	63	39894096	17
00771220	47	27313013	32	27475800	49	27726172	41	27727151	34	30251890	15	30634865	65	39894110	29
00771230	47	27313015	32	27475801	49	27726190	41	27727152	34	30251908	55	30634867	63	39894112	29
00771240	47	27313017	32	27475802	49	27726210	42	27727153	34	30251945	4	30634869	63	39894123	29
00771250	47	27313020	32	27475804	49	27726216	42	27727154	34	30251968	45	30634870	63	39894125	29
00771330	47	27313033	32	27475805	49	27726218	42	27727155	34	30251975	4	30634875	65	39894134	25
00771340	47	27313035	32	27475806	49	27726220	42	27727160	34	30252295	71	30634880	63	39894138	28
00771350	47	27313037	32	27475807	49	27726225	42	27727185	39	30252300	57	30634885	65	39894142	28
00771360	47	27313038	32	27476000	48	27726500	34	27727186	39	30252305	57	30634890	65	39894382	23
00771460	47	27313041	32	27476002	48	27726502	34	27727188	39	30252310	57	30634910	69	39894385	23
00771610	47	27313049	32	27476003	48	27726504	34	27727189	39	30252311	57	30634912	69	40451285	58
00771675	47	27313061	33	27476004	48	27726506	34	27727190	38	30252313	57	30634914	69	42735511	72
00771860	47	27313063	33	27476006	48	27726508	34	27727195	39	30252316	57	30634916	69	43070240	51
00771880	47	27313082	32	27476011	48	27726512	34	27727200	39	30252319	57	30634918	67	43075052	51
00773010	47	27313097	32	27476016	48	27726514	34	27727203	39	30252322	57	30852320	58	43075054	51
00773020	47	27313098	32	27476020	48	27726516	34	27727210	39	30252325	57	30853835	67	43075055	51
00773030	47	27318000	33	27476030	48	27726600	35	27727215	38	30252328	57	30853850	67	43075056	51
00773040	47	27318012	33	27476040	48	27726600	35	27727218	38	30252334	57	30853860	67	43075060	51
00773050	47	27318050	31	27476070	51	27726603	35	27727222	40	30252337	57	30853870	67	43075150	51
00773060	47	27318070	33	27476080	51	27726603	35	27727224	38	30252340	57	37168700	24	43075155	51
00773070	47	27318073	33	27476090	51	27726606	35	27727225	38	30252343	57	37168702	24	43075160	51
01454132	73	27318076	33	27476100	51	27726606	35	27727227	39	30252346	57	37168706	25	43075165	51
01454790	73	27318080	31	27476110	51	27726609	35	27727230	34	30254220	58	37168708	25	43151080	73
01458292	21	27330328	31	27476120	51	27726612	35	27727231	34	30254245	55	37168730	24	43151245	71
01458295	21	27330469	33	27476130	51	27726615	35	27727232	34	30254250	55	37168731	27	43151250	71
01458298	22	27330470	33	27476550	48	27726618	35	27727233	34	30254270	56	37168732	24	43151280	17
01458301	22	27330471	33	27476551	48	27726621	35	27727234	34	30254275	56	37168733	24	60850410	20
01458303	22	27330473	33	27476556	48	27726623	35	27727235	34	30254280	56	37168734	24	60850430	20
01458306	20	27330474	33	27476560	48	27726625	35	27727236	34	30254289	13	37168736	26	60850435	20
01458307	22	27330477	33	27476566	48	27726625	35	27727237	34	30254295	56	37168737	26	64510010	18
01458308	20	27330478	33	27478005	50	27726628	35	27727241	39	30254300	56	37168805	24	64510014	18
01458312	23	27330480	33	27478010	50	27726628	35	27727243	39	30254305	58	37168807	25	64510020	18
01458314	23	27330909	52	27478015	50	27726630	35	27727245	40	30254310	58	37168815	26	64510024	18
05060700	37	27330915	52	27478020	50	27726633	35	27727251	39	30254350	56	37169700	25	64510032	18
05060750	37	27330930	53	27478025	50	27726633	35	27727256	39	30254355	56	37169702	25	64510034	18
05060770	37	27330969	45	27478030	50	27726636	35	27727261	39	30254360	56	37400014	14	64510042	18
05060860	37	27330970	45	27478040	50	27726639	35	27727266	39	30254365	56	37400050	14	64510140	19
05060870	37	27330973	45	27478050	50	27726642	35	27727280	40	30254370	56	37400052	14	64510142	19
05060880	37	27330975	45	27721000	43	27726645	35	27727290	40	30254400	42	37400054	14	64510144	19
05060890	37	27330976	45	27721010	43	27726648	35	27727301	42	30362920	58	39893110	63	64510146	19
05060900	37	27330979	45	27721050	43	27726654	35	27727307	42	30634040	57	39893115	63	64510199	8
05060920	37	27330980	45	27721060	43	27726654	35	27727345	42	30634045	57	39893117	63	64510337	8
05060960	37	27330981	45	27721070	43	27726657	35	27727347	42	30634570	66	39893120	63	64510347	12
07350047	9	27330983	45	27721080	43	27726657	35	27727349	42	30634575	66	39893122	63	64510348	12
07350051	9	27330986	45	27721100	43	27726660	35	27727420	46	30634576	66	39893123	63	64510352	12
07350053	9	27330987	45	27721110	43	27726660	35	27727500	35	30634578	66	39893124	63	64510358	12
07350080	9	27330989	45	27721120	43	27726663	35	27727500	35	30634580	66	39893299	60	64510360	8
07350095	9	27330991	45	27721130	43	27726666	35	27727502	35	30634582	66	39893300	60	64510370	7
07350097	59	27330993	45	27721140	43	27726669	35	27727502	35	30634584	66	39893303	60	64510380	7
07350120	9	27331130	50	27721150	43	27726672	35	27727504	35	30634586	66	39893304	60	64530995	6
07350800	13	27331140	50	27721160	43	27726675	35	27727504	35	30634588	66	39893307	62	64531002	6
07350810	7	27331145	50	27721210	43	27726681	35	27727506	35	30634601	68	39893309	62	64531006	6
07351029	10	27331150	50	27721220	43	27726681	35	27727510	35	30634610	68	39893317	60	64531010	6
07351034	10	27331165	50	27721230	43	27726684	35	27727508	35	30634640	68	39893321	61	64538007	6
07351046	10	27331170	49	27721250	43	27726684	35	27727512	35	30634642	68	39893325	61	64538009	6
07351065	11	27331171	49	27721255	43	27726687	35	27727514	35	30634644	68	39893327	66	64538014	7
07351066	11	27331172	49	27721260	43	27726690	35	27727520	35	30634646	68	39893331	59	64538019	7
07351120	11	27331173	49	27721270	43	27726693	35	27727522	35	30634648	68	39893335	59	64550001	5
07351122	11	27331250	49	27721280	43	27726696	35	27727524	35	30634650	68	39893337	59	64550010	5
09002112	17	27331251	49	27721290	43	27726699	35	27727526	35	30634652	68				

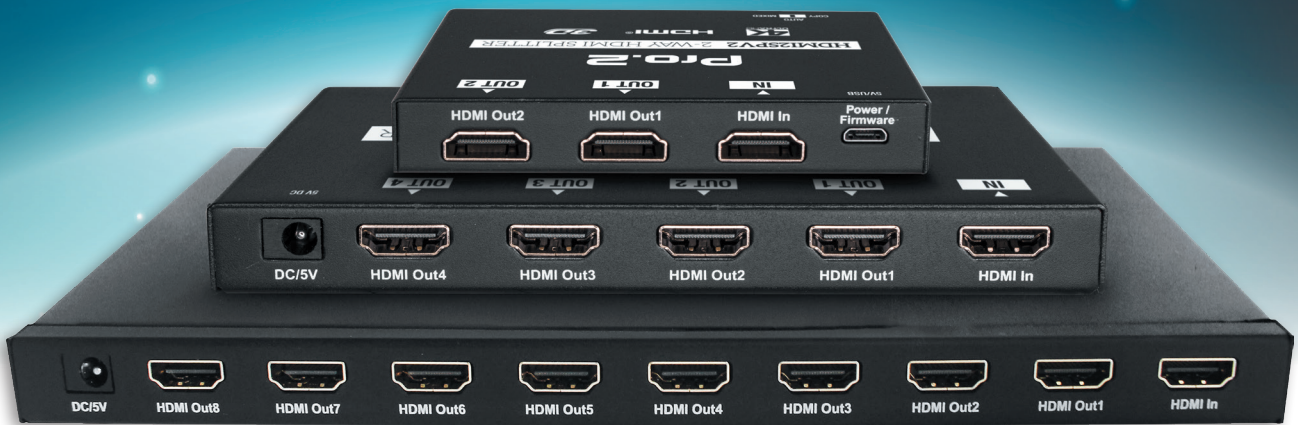

MODEL: HDMI2SPV2

CODE: 64510014

OUTPUT 2 Way

POWER USB



MODEL: HDMI4SPV2

CODE: 64510024

OUTPUT 4 Way

POWER 5V DC



MODEL: HDMI8SPV2

CODE: 64510034

OUTPUT 8 Way

POWER 5V DC

4K18
ULTRAHD GBPS

HDMI®
HIGH SPEED

3D

Deep Colour

x.v.Colour

GOLD
PLATED CONNECTORS

Pro2's high quality HDMI splitters take a single signal input – Blu-ray, HD TV, PayTV (Foxtel), Xbox, PlayStation etc. – and split them into multiple outputs without any signal loss.

- Slim design, great for hiding behind TVs
- Up to 4K HDMI 2.0 UHD
- Great for today's 1080p 3D
- Supports 36 bit Deep Colour
- Display resolutions up to 3840 x 2160
- Powered for extended cable runs, equalising signals and re-clocking output
- Built-in EDID simulator and HDCP key-set allows each output to work independently when connecting to an HDMI display
- Ideal for a simple home setup up to a 16 monitor commercial installation
- Robust metal case of solid construction

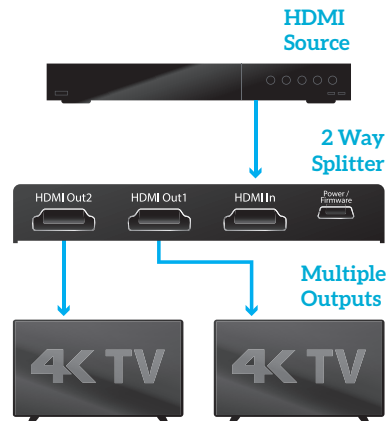

4 EASY WAYS TO SHOP RADIOPARTS.COM.AU

1 ONLINE
www.radioparts.com.au

2 IN STORE
Visit our showroom for product demonstrations

3 OVER THE PHONE
Call toll free: 1800 337 366

4 VIA FAX
Toll free fax: 1800 659 963

TRADE SALES TEAM

SALES MANAGER: MICHAEL SWANN 0404 877 905
EAST VICTORIA: JOE CIOTTA 0417 140 222
WEST VICTORIA: DARREN ROWLANDS 0419 366 980
 SA, NT, WA
NORTH VICTORIA: BEN MARSHALL 0418 531 965
 QLD, TAS
SYDNEY: MARK DE HAVILLAND 0424 184 454
 NSW, ACT FRANK MANICASTRI 0437 179 495

RADIO PARTS DIAL-DIRECT

SALES: (03) 9321 8300 **SHOWROOM:** (03) 9321 8329

ACCOUNTS

A-J: (03) 9321 8364 **K-Z:** (03) 9321 8362

or call us toll free: **1800 337 366**



MAIN OFFICE

562 Spencer St., West Melbourne, VIC 3003
T: (03) 9321 8300 **F:** (03) 9321 8333
E: info@radioparts.com.au

Mon - Fri: 7:30am - 5:30pm **Sat:** 9am - 4pm

We accept:



TERMS & CONDITIONS Product features in this brochure are subject to change without notice. Availability of products are offered on a while stocks last basis. Most products have been photographed in-house and are identical to what you will receive, but manufacturers may make improvements during the life of a product without notice and this may result in a slightly different design. If certain product features are important, please contact the dealer for confirmation before ordering the product. Information presented in this brochure has been checked and is believed to be correct at the time of printing, however, errors and omissions are accepted. PRO2 can not guarantee specifications, or features of a product as they may change after printing.